

© REGISTERED TRADEMARK OF ALLIED RADIO CORP.—100 NORTH WESTERN AVENUE, CHICAGO 80, ILLINOIS — TELEPHONE HAYMARKET 1-6800

copyright 1961 by Allied Radio Corp/printed in U.S.A.

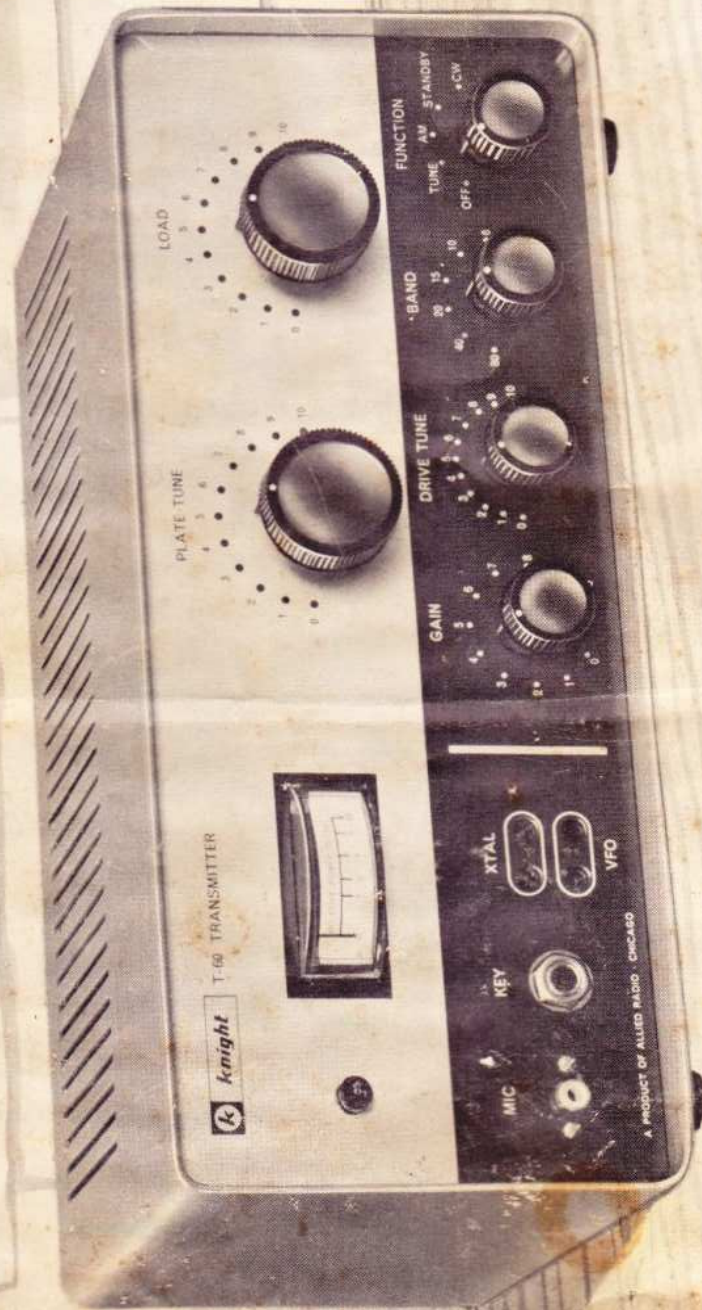

T-60 60-WATT AM-CW TRANSMITTER

**ASSEMBLY MANUAL**

**knight-kit®**





# Thank You...

for your interest in Knight-Kits.

This Assembly Manual represents our many decades of experience in developing electronic kits which bring you outstanding performance at dollar-saving prices . . . and with maximum ease of construction.

*As you go through the pages of this brochure, note how carefully each stage of construction is explained—how each diagram is magnified so that you almost have the feeling a good instructor is working at your side!*

Knight-Kit's "do and check" method of kit-building insures accurate and simple assembly. Although your final product may represent a very complicated piece of electronic equipment, you will proceed with ease and assurance, step-by-step . . . and enjoy enormous satisfaction in your completed working unit.

Every Knight-Kit of your choice is available to you on the Allied Credit Fund Plan—

- No Money Down
- 24 Months To Pay
- Up To 50% Increased Buying Power

Your Knight-Kit purchase is backed with our exclusive and iron-clad guarantee—you must be *completely* satisfied or your purchase price is refunded!

It is always a pleasure to serve you.

*A. D. Davis*

A. D. Davis, President





# T-60

## 60-Watt AM-CW Amateur Transmitter Kit



YOUR NEW KNIGHT-KIT T-60 IS THE GREATEST VALUE in a phone and CW transmitter kit available anywhere. It contains all the most-wanted features asked for by Novices looking for a "first rig" — plus sufficient power and frequency coverage to make it an excellent transmitter for the Technician as well as the Advanced Amateur who wants a "standby" transmitter.

YOU'LL BE PROUD OF YOUR KNIGHT-KIT T-60 TRANSMITTER. Expertly engineered by a skilled staff of kit specialists and field tested to assure perfect performance, the T-60 is guaranteed to provide complete satisfaction. The professional styling of the T-60 was developed by leading designers to make you genuinely proud of your kit's appearance as well as its performance.

- COMPACT, VERSATILE AM-CW TRANSMITTER
- SINGLE KNOB BAND SWITCHING FROM 80 THROUGH 6 METERS
- CARRIER CONTROLLED AM MODULATION
- BIAS RESISTOR KEYING
- CLEAN CHIRP-FREE KEYING
- METER INDICATES RELATIVE RF OUTPUT
- SILICON RECTIFIER POWER SUPPLY



## CONSTRUCTION HINTS

### UNPACKING

If you are not familiar with electronic parts, we suggest that you check each part against the parts list in the rear of the manual. If you are unable to identify some of the parts, find their pictures on the wiring illustrations or on the parts identification photo. As you check off the parts, assort them so they are readily available. You may find it advantageous to sort the hardware (screws, nuts, lockwashers, etc.) into suitable containers. This step will acquaint you with the various parts and thus simplify building.

### HELPFUL CONSTRUCTION HINTS

This book uses some symbols to the value of the parts. "Ω" means ohm, "K" means one thousand ohms, "meg" means one million ohms,  $\mu\text{f}$  means microfarad, and  $\mu\mu\text{f}$  means micromicrofarad. Capacitors markings may be  $\mu\text{f}$  or MF for microfarad;  $\mu\mu\text{f}$  or MMF for micro-microfarad.

Several types of wire are supplied. It is important to use the wire called for in the building step.

Insulated solid and stranded wire, identified by color, has been cut to length and prestripped for your convenience. Use only the color given in the step.

The construction of this kit will require the use of a soldering iron, rated at about 100 watts, a pair of long-nose pliers, a pair of diagonal cutters, and a screwdriver.

Follow the step-by-step instructions exactly. DO NOT ATTEMPT TO WIRE THIS KIT FROM THE PICTORIALS OR SCHEMATIC DIAGRAM ALONE because a definite wiring sequence must be followed. Occasionally, several parts are mounted with the same hardware, so BE SURE TO READ THE ENTIRE STEP. Check off each step after you have completed it.

The leads from electrical components must be held in place by good mechanical connections. A lead held in place by solder alone is a potential source of trouble.

To make a good mechanical connection, simply insert the end of the lead through the hole in the terminal; wrap the lead around the terminal and cut off the excess wire. Clamp the connection with your long-nose pliers. Figure 1 illustrates a connection that has been properly made.

Flexible tubing is used to cover bare wire or leads where there is a chance they may touch other bare wires or the chassis. BARE WIRES AND BARE LEADS NOT CONNECTED TO THE SAME TERMINAL MUST NOT ACCIDENTLY TOUCH EACH OTHER OR THE CHASSIS.

### HOW TO CARE FOR YOUR SOLDERING IRON

Before you start to solder, carefully clean the tip of your soldering iron with a fine file, or with steel wool, until the bright metal surface of the tip is exposed. Heat the iron; then cover (tin) the tip with a thin layer of ROSIN CORE SOLDER. While the iron is hot, remove excess solder from the tip by wiping with a clean cloth.

When the tip of the iron becomes covered with a dull, oxide film, wipe the tip with a clean cloth, and re-tin the iron.

To transfer the full heat of the iron, hold its greatest tip surface to the connection.

Never use the iron like a brush—soldering is not a paste-spreading operation.



# THIS KIT MUST BE PROPERLY SOLDERED!

## USE ENOUGH HEAT

This is the main idea of good soldering. Apply enough heat to the metal surfaces you are joining to make the solder spread freely, until the contour (shape) of the connection shows under the solder.

**AN ELECTRONIC UNIT WILL NOT WORK . . .** unless it is properly soldered. Read these instructions carefully to understand the basic ideas of good soldering.

Enough heat must be used so the solder can actually penetrate the metal surfaces, making an unbroken path over which electricity can travel. You are not using enough heat if the solder barely melts and forms a rounded ball of rough, flaky solder.

## Use the Right Soldering Tool

A soldering iron in the 40-100 watt range is recommended. Any iron in this range with a clean, chisel-shaped tip will supply the correct amount of heat to make a good solder connection. You may also use a solder gun but make sure the tip reaches full heat before you solder.

Keep the iron or gun tip brightly coated with solder. When necessary, wipe the hot tip clean with a cloth. If you are using an old tip, clean it before you start soldering. Use a fine file or steel wool to expose the bright metal. Heat the iron and immediately coat the tip with solder.

## Use Only Rosin Core Solder

We supply the right kind of solder (*rosin core solder*). Do not use any other kind of solder! Use of Acid Core Solder, Paste, or Irons Cleaned on a Sal Ammoniac Block will ruin any Electronic Unit and will Void the Guarantee.

## HERE'S HOW TO DO IT . . .

1. Join bare metal to bare metal; insulation must be removed. Make good mechanical connections and keep resistor and capacitor leads as short as possible, unless otherwise specified.
2. Coat the tip of a hot iron with solder. Then Firmly Press the Flat Side of the Tip against the parts to be soldered together. Keep the iron there while you . . .
3. Apply the solder between the iron tip and the metal to be soldered. Use only enough solder to flow over all surfaces of the connection, and all wires in the connection. Remove the iron.

**Do Not Move Parts Until the Solder Hardens.** If you accidentally move the wires as the solder is hardening, apply your iron and reheat.

4. Compare your soldering with the pictures on this page. You have a good connection if your solder has flowed over all surfaces to be connected, following the shape of the surfaces. It should appear smooth and bright and all wires in the connection should be well-soldered.

**You Have Not Used Enough Heat:** If your connection is rough and flaky-looking, or if the solder has formed a round ball instead of spreading.

The difference between good soldering (enough heat) and poor soldering (not enough heat) is just a few extra seconds with a hot iron firmly applied. Remember, larger metal surfaces take a longer time to heat.

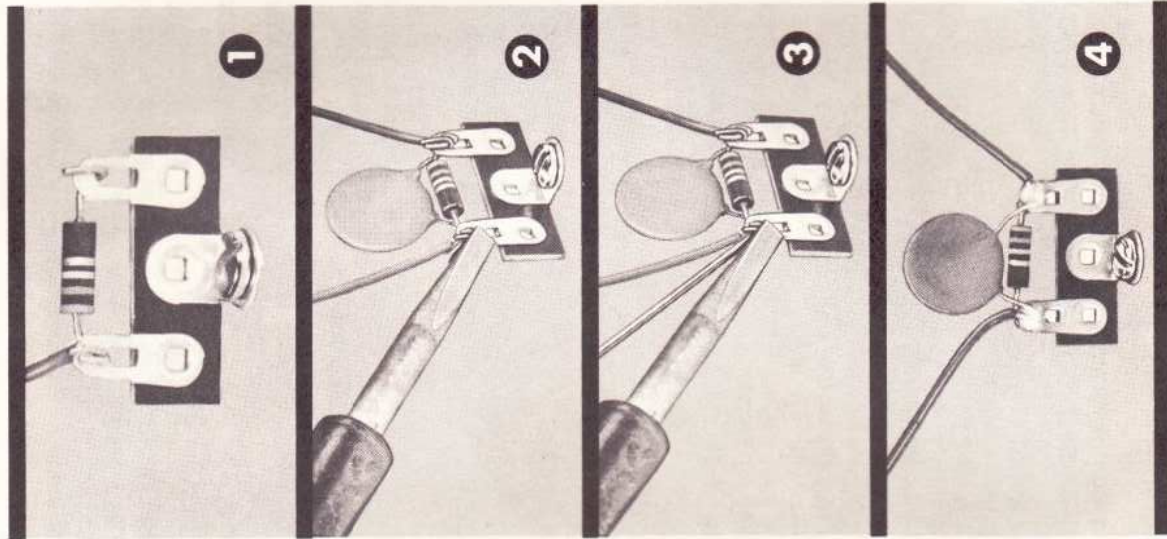

FIGURE 1



# PARTS MOUNTING—CHASSIS

## SEE FIGURES 2 AND 6

- ✓ Three 1/2" grommets. Mount in the holes shown.
- ✓ Two 1/4" grommets. Mount in the holes shown.
- ✓ 8-pin tube socket for V4 (largest socket) and two 3/4" spacers. See Figure 3. From the top of the chassis, insert a 6-32 x 1 1/4" screw through each of the mounting holes. Place a 3/4" spacer and a nut over each of the screws. Then place the tube socket over the screws so the keyway points toward the back of the chassis. Loosely fasten with two #6 lockwashers and nuts.
- ✓ Insert V4 (6DQ6B) in the tube socket by rotating the tube until the key of the tube base engages the keyway of the socket, and press firmly. When the tube is properly seated in the socket, tighten the two mounting nuts and remove the tube.

**NOTE:** It is sometimes helpful to write the part symbol on the chassis with a soft pencil or crayon. Make sure the tube sockets and terminal strips are positioned exactly as shown in Figure 2.

- ✓ 9-pin tube socket for V2 and shield base. Mount the base to the top of the chassis. Mount the socket to the inside of the chassis with the keyway as shown. Fasten with two 4-40 x 1/4" screws, lockwashers, and nuts. The keyway is the wide space between two of the pins.
- ✓ 9-pin tube socket for V1. Fasten to the inside of the chassis with two 4-40 x 1/4" screws, lockwashers and nuts.
- ✓ TS-7, 6-terminal strip. Fasten with a 6-32 x 1/4" screw, lockwasher, and nut.
- ✓ TS-6, 5-terminal strip. Fasten with a 6-32 x 1/4" screw, lockwasher, and nut.
- ✓ TS-5, 6-terminal strip. Fasten with a 6-32 x 1/4" screw, lockwasher, and nut.
- ✓ TS-10, 3-terminal strip. Fasten with a 6-32 x 1/4" screw, lockwasher, and nut.
- ✓ J2, 8-pin accessory socket, and solder lug. Position the socket with the keyway as shown in Figure 2. Place the solder lug between the socket and lockwasher at the point shown and fasten with two 6-32 x 1/4" screws, lockwashers, and nuts.
- ✓ SW-1 slide switch. Mount so terminals are positioned as shown in Figure 2. Fasten with two 6-32 x 1/4" screws, lockwashers, and nuts.

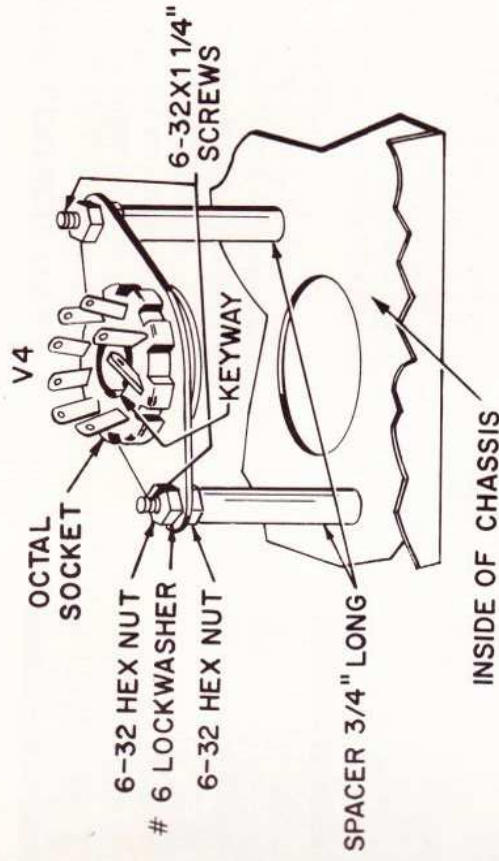

FIGURE 3

- ✓ J1, coaxial output connector. Position so the slanted part of the terminal is up. Fasten with four 4-40 x 1/4" screws, lockwashers, and nuts.
- ✓ J3, key jack. Place a 3/8" lockwasher over the front of the jack. Position the terminals as shown and fasten to the chassis with a 3/8" nut.
- ✓ J4, crystal VFO socket. Position the keyway as shown and fasten with two 6-32 x 1/4" screws, lockwashers, and nuts.
- ✓ C-30, single-gang variable capacitor. Carefully inspect the plates of the capacitor to make sure they are not bent or touching each other. Close the capacitor so the plates are fully meshed. Position as shown and fasten with three 6-32 x 1/4" screws. Be sure the bottom terminals are not touching the chassis.
- ✓ K30, 100K control. Mount the control so the locating tab fits into the small hole in the chassis. Fasten with a 3/8" nut.
- ✓ Ground bolt. Insert an 8-32 x 3/4" screw through the rear panel as shown, and fasten with a #8 lockwasher and nut. Thread the knurled nut over the screw.



# PARTS MOUNTING—CHASSIS

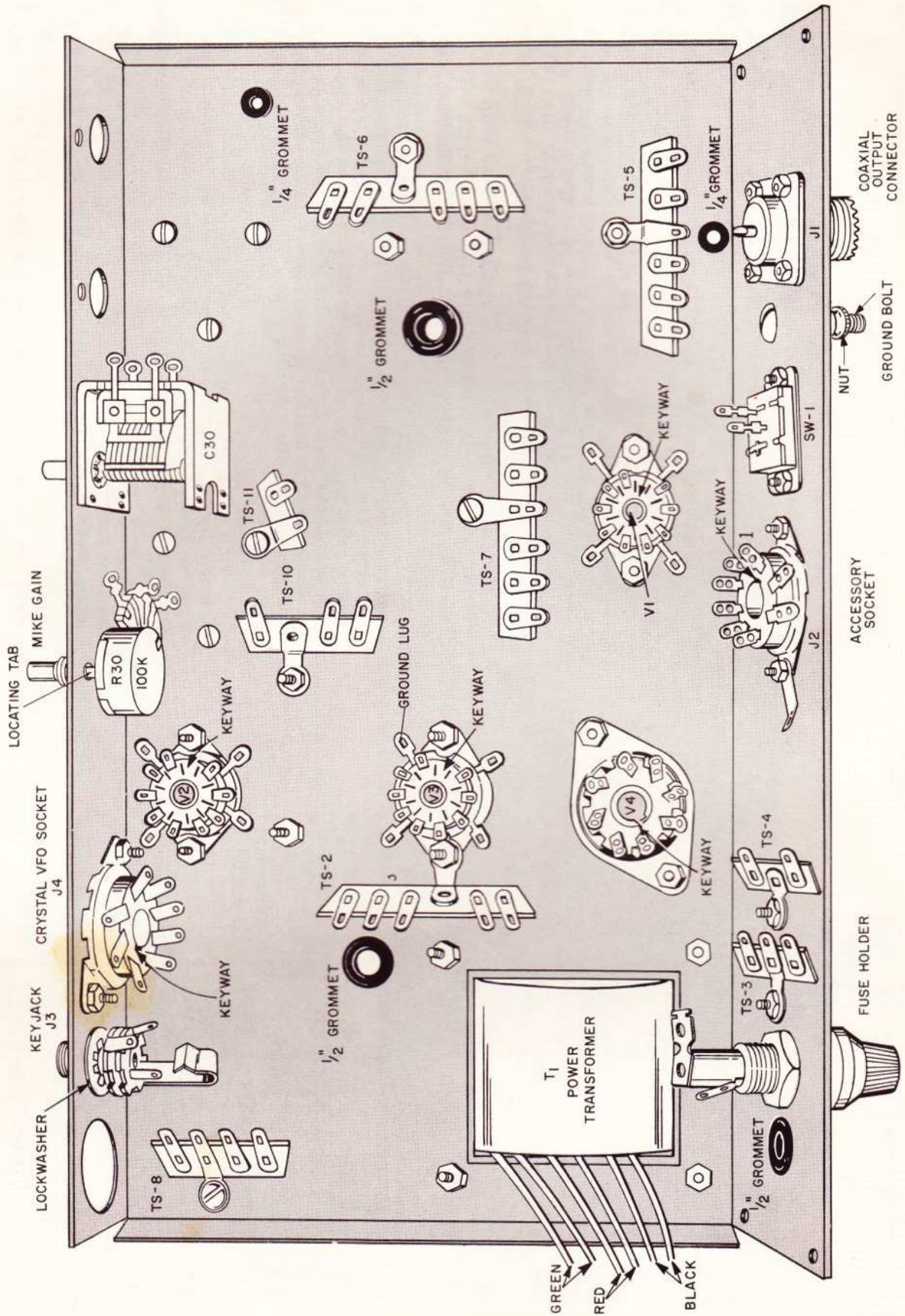

FIGURE 2



## PARTS MOUNTING—CHASSIS

- ✓ Power transformer T1. Mount with leads in position shown. Fasten with four #8 lockwashers and nuts.
- ✓ TS-4, 2-terminal strip. Fasten with a 6-32 × 1/4" screw, lockwasher, and nut.
- ✓ TS-3, 3-terminal strip. Fasten with a 6-32 × 1/4" screw, lockwasher, and nut. Be sure the terminal strip is not touching the bolt of the transformer.
- ✓ Fuse holder. Remove the nut and metal lockwasher from the fuse holder. Leave the rubber washer in place. Insert the fuse holder through the rear panel of the chassis. Position the terminals as shown and fasten with the lockwasher and nut.
- ✓ 9-pin tube socket for V3; TS-1, 3-terminal strip; TS-2, 5-terminal strip. Position the tube socket with the keyway as shown. Position TS-2 between the tube socket and chassis. Fasten these parts with a 4-40 × 1/4" screw, lockwasher, and nut. See Figure 4. Mount TS-1 to the top of the chassis. Insert a 4-40 × 1/4" screw through the terminal strip and other side of tube socket. Fasten with a #4 lockwasher and nut.
- ✓ TS-8, 4-terminal strip and TS-9, 5-terminal strip. See Figure 5. Position TS-9 on top of the chassis and TS-8 on the bottom. Fasten these parts with a 6-32 × 1/4" screw, lockwasher, and nut.
- ✓ C-15, 2-gang, wide-spaced variable capacitor; and TS-11, 2-terminal strip. Position the capacitor on top of the chassis. See Figure 6. Insert a 6-32 × 1/4" screw through TS-11 and fasten to the capacitor as shown in Figure 2. Thread a 6-32 × 1/4" screw into the two remaining holes in the capacitor. Place a lockwasher under each screw.
- ✓ C-16, 2-gang variable capacitor. Position as shown in Figure 6. Fasten with three 6-32 × 1/4" screws, and lockwashers.
- ✓ TS-12, 2-terminal strip. Mount to the top of the chassis. Fasten with a 6-32 × 1/4" screw, lockwasher, and nut.
- ✓ L Bracket for tank coil. Mount on top of chassis. Fasten with two 6-32 × 1/4" screws, lockwashers, and nuts.

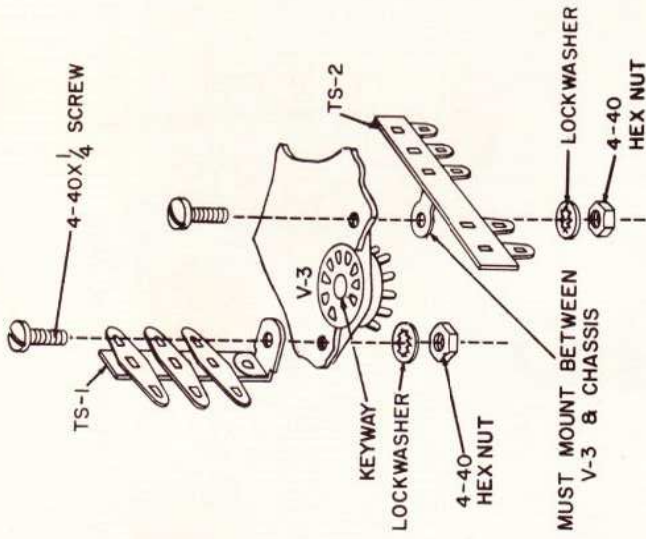

FIGURE 4

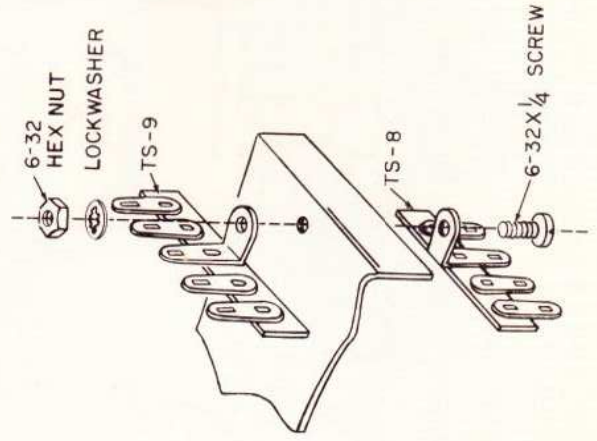

FIGURE 5



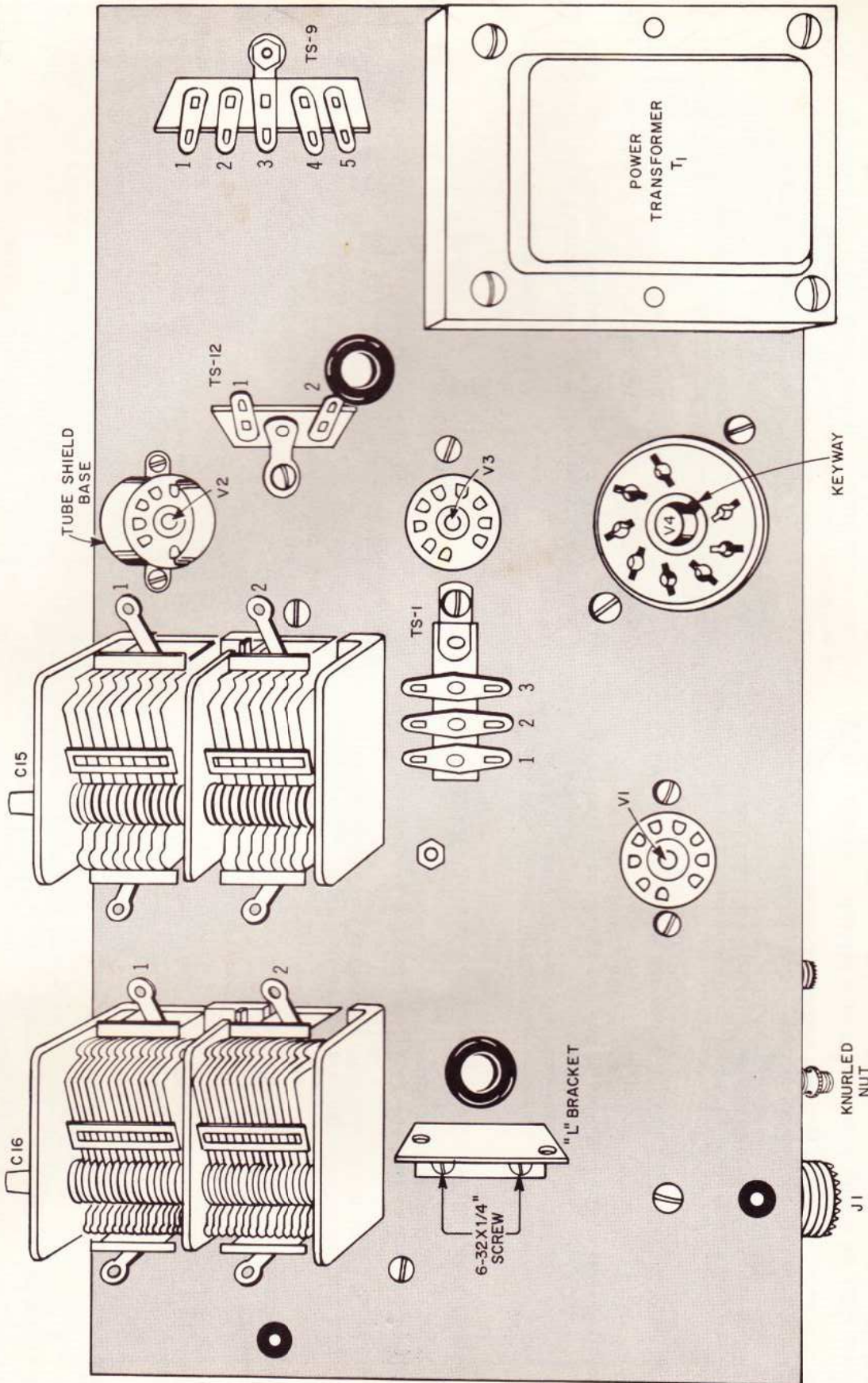

FIGURE 6



## IMPORTANT INSTRUCTIONS

**CONNECT means:** Connect the wire or lead to the given point. Make a firm mechanical connection **BUT DO NOT SOLDER AT THIS TIME**. Later another wire (s) will be connected at this point.

**SOLDER means:** Connect the wire or lead to the given point and then **SOLDER THE CONNECTION AND ALL WIRES IN IT**. If there is more than one wire in the connection, the number of wires will be stated. For example, if the building step tells you to "solder the shield wire to the solder lug (4 wires)," it means there should be four wires connected to that solder lug when you solder it. **If you do not have the stated number of wires, you have made an error. Go back and check your work.**

## SEE FIGURE 7

1" bare wire. Solder one end to pin 5 of V2. Feed the other end through pins 4 and 3 and connect to ground lug near pin 3. Solder pins 4 and 3.

Red wire. Solder one end to ground lug near pin 8 of V2. Connect the other end to terminal 1 of R30.

3/4" bare wire. Solder one end to pin 8 of V3. Solder the other end to ground lug of V3 socket.

3/4" bare wire. Solder one end to pin 4 of V1 socket. Solder the other end to ground lug on V1 socket.

1 1/2" bare wire. Connect one end to terminals 1 and 2 of J3. Solder pin 2. Connect the other end to pin 1 of J4.

Red wire. Solder one end to terminal 1 on slide switch SW1. Connect the other end to ground lug of V1.

Red wire. Connect one end to pin 7 of V4. Connect the other end to ground lug bolted to accessory socket J2.

Red wire. Connect one end to pin 6 of J2. Connect the other end to ground lug bolted to accessory socket J2.

Refer to Figure 7. Note position of wires on power transformer (T1). Twist the two green wires and route them along chassis bottom under the fuse holder, TS-3, and TS-4. Connect one wire to pin 2 of socket J2. Connect the other wire to pin 7 of V4.

3/4" bare wire. Solder one end to pin 4 of V3. Solder the other end to the ground lug near pin 4.

Orange wire. Solder one end to pin 2 of socket J2 (2 wires). Connect the other end to pin 5 of V1.

Green wire. Solder one end to pin 5 of V1 (2 wires). Connect the other end to pin 2 of V4.

Yellow wire. Solder one end to pin 2 of V4 (2 wires). Connect the other end to pin 5 of V3.

Yellow wire. Solder one end to pin 5 of V3 (2 wires). Solder the other end to pin 9 of V2.

R8, 4.7K resistor (yellow, violet, red). Cut leads to 1". Connect one lead to terminal 1 of TS-8. The other lead will be connected later.

R9, 2.2 meg resistor (red, red, green). Cut leads to 1". Connect one lead to terminal 1 of TS-8. The other lead will be connected later.

R7, 2.2K, 3-watt resistor (square shaped). Connect one lead to terminal 1 of J3. Connect the other lead to terminal 3 of J3.

C17, .005  $\mu$ f, disc capacitor. Solder one lead to terminal 1 of J3 (3 wires). Connect the other lead to terminal 3 of J3.

C1, 25  $\mu$ f, disc capacitor. Connect one lead to pin 1 of J4. Connect the other lead to pin 3 of J4.

R1, 56K resistor (green, blue, orange). Solder one lead to pin 1 of J4 (3 wires). Connect the other lead to pin 3 of J4.

3/4" bare wire. Solder one end to pin 3 of J4 (3 wires). Connect the other end to pin 5 of J4.

Orange wire. Solder one end to pin 7 of V2. Solder the other end to terminal 2 of R30.

R13, 470 $\Omega$  resistor (yellow, violet, brown). Solder one lead to terminal 1 of R30 (2 wires). Connect the other lead to pin 8 of V2.

C19, .01  $\mu$ f, 400V, tubular capacitor. Solder one lead to terminal 3 of R30. Connect the other lead to pin 1 of V2.

Cut a piece of shielded wire 5" long. See Figure 8 for cable preparation. From one end, remove 1/2" of outer plastic cover and shield. Remove 1/4" of insulation from the center conductor. From the other end, remove 3/4" of plastic cover, unravel shield and twist into single conductor. Remove 1/4" of insulation from the center conductor.



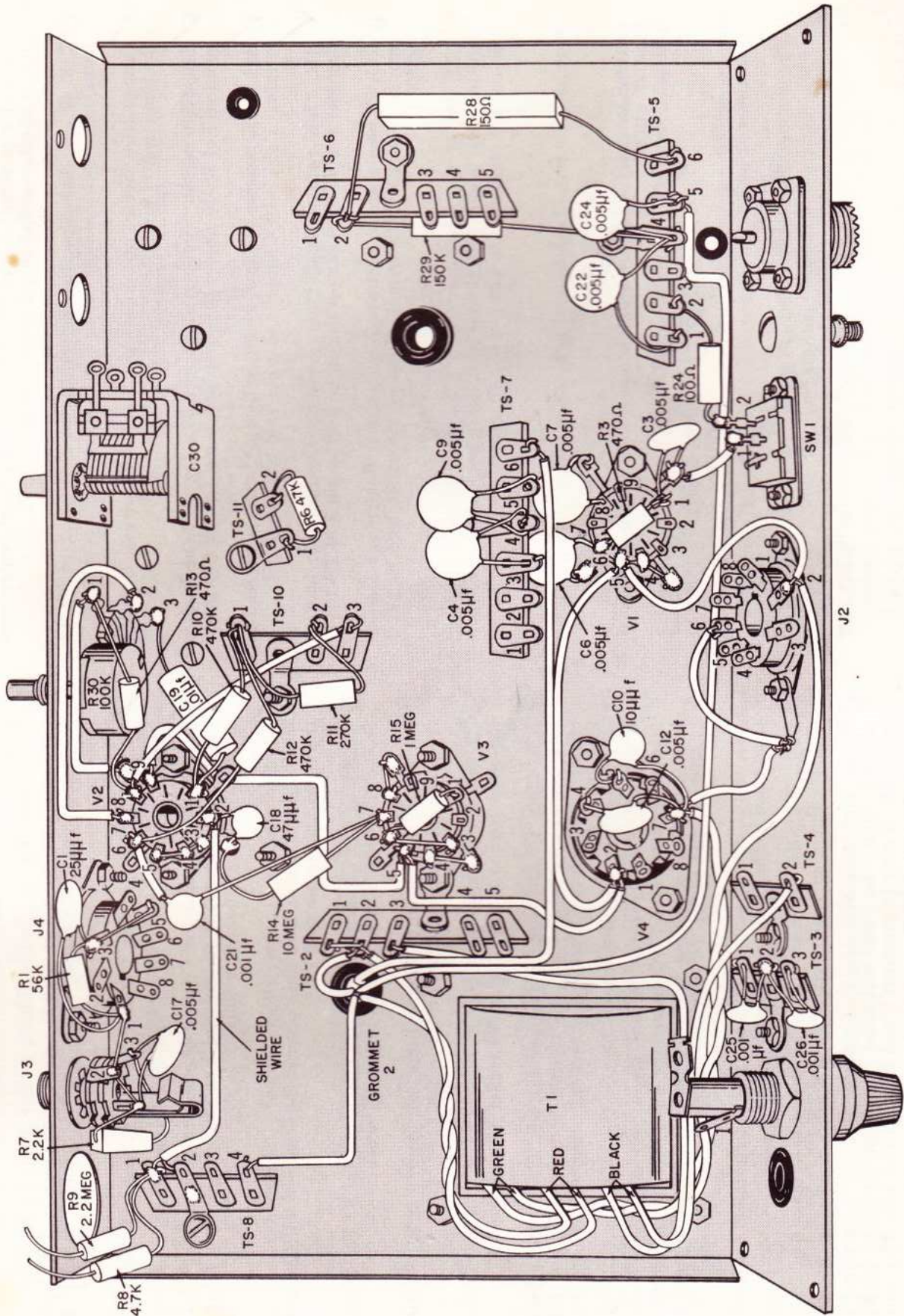

FIGURE 7



## FIRST WIRE, "G" - BOTTOM

- Prepared shielded wire. Take end with shield, and insert shield in the lower hole of terminal 2 of TS-8 and solder. Solder center conductor to terminal 1 of TS-8 (3 wires). Connect center conductor of other end of shielded cable to pin 2 of V2.
- C18, 47  $\mu\text{f}$ , disc capacitor. Solder one lead to pin 2 of V2 (2 wires). Connect the other lead to ground lug on V2 socket.
- Orange wire. Solder one end to pin 8 of V2 (2 wires). Connect the other end to terminal 3 of TS-10.
- R10, 470K resistor (yellow, violet, yellow). Connect one lead to terminal 1 of TS-10. Solder the other lead to pin 1 of V2 (2 wires).
- R12, 470K resistor (yellow, violet, yellow). Connect one lead to terminal 1 of TS-10. Connect the other lead to pin 6 of V2.
- R11, 270K resistor (red, violet, yellow). Connect one lead to terminal 1 of TS-10. Connect the other lead to pin 2 of TS-10.
- R14, 10 meg resistor (brown, black, blue). Solder one lead to ground lug on V2 (3 wires). Connect the other lead to pin 7 of V3.
- C21, .001  $\mu\text{f}$ , disc capacitor. Cut a 1" piece of black tubing and slip over one lead of C21. Solder this lead to pin 6 of V2 (2 wires). Solder the other lead to pin 7 of V3 (2 wires).

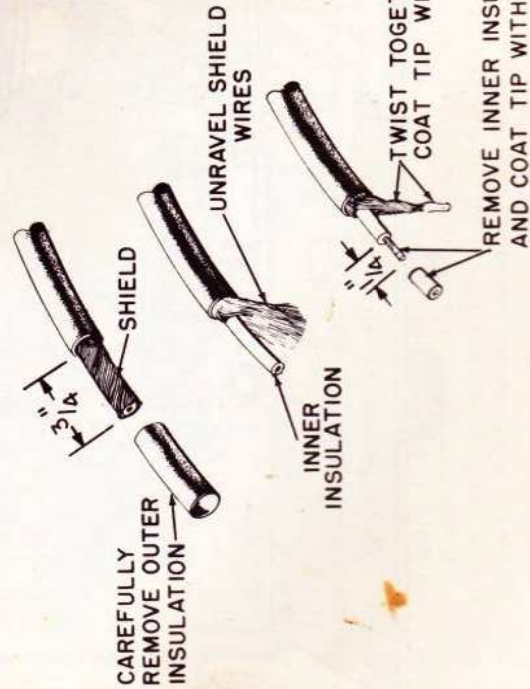

FIGURE 8

- R6, 47K resistor (yellow, violet, orange). Connect one lead to terminal 1 of TS-11. Connect the other lead to terminal 2 of TS-11.
- R15, 1 meg resistor (brown, black, green). Connect one lead to pin 1 of V3. Place resistor close to socket. Pass other lead through the hole of pin 6 of V3, then to pin 3 of V3. Solder pins 3 and 6 of V3.
- C4, .005  $\mu\text{f}$ , disc capacitor. Connect one lead to terminal 3 of TS-7. Connect the other lead to terminal 4 of TS-7.
- C9, .005  $\mu\text{f}$ , disc capacitor. Connect one lead to terminal 4 of TS-7. Connect the other lead to terminal 5 of TS-7. Make sure values stamped on capacitors are visible.
- R3, 470 $\Omega$  resistor (yellow, violet, brown). Connect one lead to pin 1 of V1. Place resistor flush against the socket of V1. Connect the other lead to pin 6 of V1.
- C6, .005  $\mu\text{f}$ , disc capacitor. Solder one lead to pin 6 of V1 (2 wires). Solder the other lead to ground lug on V1 socket.
- C7, .005  $\mu\text{f}$ , disc capacitor. Connect one lead to pin 8 of V1. Solder the other lead to ground lug on V1 socket.
- C3, .005  $\mu\text{f}$ , disc capacitor. Connect one lead to pin 1 of V1. Solder the other lead to ground lug on V1 socket (2 wires).
- R28, 150 $\Omega$ , 10-watt resistor (square shaped). Connect one lead to terminal 2 of TS-6. Place the resistor body flush against the chassis as shown in Figure 7. Connect the other lead to terminal 6 of TS-5.
- R29, 150K, 2-watt resistor (brown, green, yellow). Connect one lead to terminal 2 of TS-6. Insert the other lead in the bottom hole of terminal 4 of TS-5. Cut off excess lead on the other side of terminal and solder the bottom hole only.
- C22, .005  $\mu\text{f}$ , disc capacitor. Connect one lead to terminal 1 of TS-5. Connect the other lead to terminal 4 of TS-5.
- C24, .005  $\mu\text{f}$ , disc capacitor. Connect one lead to terminal 4 of TS-5. Connect the other lead to terminal 5 of TS-5.
- White wire with blue tracer. Connect one lead to terminal 5 of TS-5. Route the other end along bottom of chassis as shown in Figure 7, over to grommet 2 and through the hole. This wire will be connected later.
- R24, 100 $\Omega$  resistor (brown, black, brown). Connect one lead to terminal 2 of TS-5. Solder the other lead to terminal 2 of SW-1.



# FIRST WIRING—BOTTOM

- C12, .005  $\mu$ f, disc capacitor. Connect one lead to pin 7 of V4. Connect the other lead to pin 4 of V4.
- C10, 10 $\mu$ f, disc capacitor. Solder one lead to pin 7 of V4 (4 wires). Connect the other lead to pin 5 of V4.
- Connect one black lead from transformer T1 to terminal 2 of TS-4.
- Connect other black lead from power transformer T1 to terminal 3 of TS-2.
- Twist together the red leads from power transformer T1 as shown in Figure 7. Connect one lead to terminal 2 of TS-2.
- Connect  $\frac{3}{4}$ " piece of bare wire from terminal 1 to terminal 2 of TS-2.
- Green wire. Connect one end to terminal 2 of TS-2 and pass other end through grommet 2. This wire will be connected later.
- Pass other red wire from power transformer T1 through grommet 2. This wire will be connected later.
- C25, .001  $\mu$ f, disc capacitor. Connect one lead to terminal 1 of TS-3. Connect the other lead to terminal 2 of TS-3.
- C26, .001  $\mu$ f, disc capacitor. Solder one lead to terminal 2 of TS-3 (2 wires). Connect the other lead to terminal 3 of TS-3. Make sure no wires touch the power transformer mounting bolt.
- Gray wire. Connect one end to terminal 6 of TS-7. Route as shown in Figure 7, and pass other end through grommet 2. This wire will be connected later.
- Violet wire. Connect one end to terminal 4 of TS-8. Pass other end through grommet 2.

## BAND SWITCH SW3 PREWIRING

### SEE FIGURE 9

- Red wire, Connect one end to terminal 1 of SW3. Connect the other end to terminal 6.
- Red wire. Connect one end to terminal 2. Connect the other end to terminal 7.
- Red wire. Connect one end to terminal 3. Connect the other end to terminal 8.

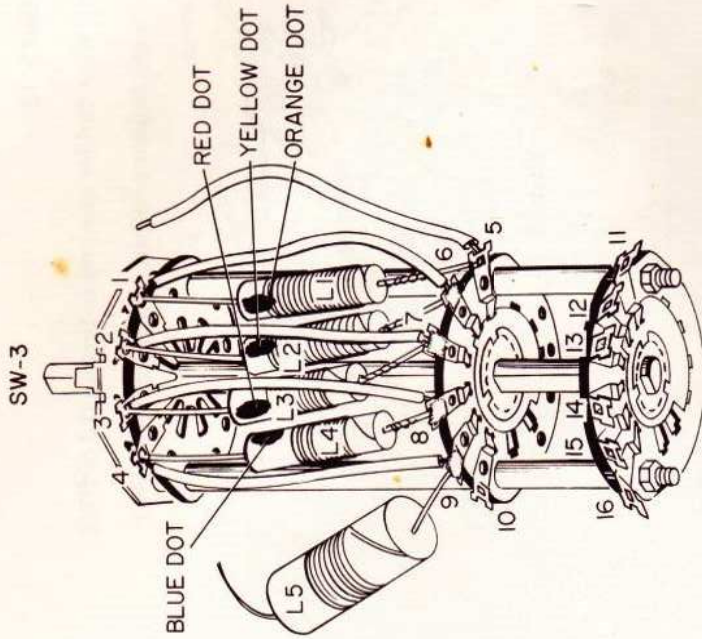

FIGURE 9

- Red wire. Connect one end to terminal 4. Connect the other end to terminal 9.
- Orange wire. Connect one end to terminal 5. Route as shown.
- RF coils, L1, L2, L3, L4 (with colored dots). Cut all leads to  $\frac{1}{2}$ " before mounting on Band switch SW3.
- L1, RF coil, 90 microhenries ( $\mu$ h), orange dot. Solder one lead to terminal 1 (2 wires). Connect the other lead to terminal 5.
- L2, RF coil, 24  $\mu$ h, yellow dot. Solder one lead to terminal 2 (2 wires). Solder the other lead to terminal 6 (2 wires).
- L3, RF coil, 1.5  $\mu$ h, red dot. Solder one lead to terminal 3 (2 wires). Solder the other lead to terminal 7 (2 wires).
- L4, RF coil, 3.3  $\mu$ h, blue dot. Solder one lead to terminal 4 (2 wires). Solder the other lead to terminal 8 (2 wires).
- L5, RF coil, 1.6  $\mu$ h, no dot, wound on  $\frac{7}{16}$ " diameter form. Cut one lead to  $\frac{3}{4}$ ". Solder this lead to terminal 9 (2 wires).



## FUNCTION SWITCH SW2 PREWIRING

SEE FIGURE 10

- Gray wire. Solder one end to terminal 3 of SW2.
- Red wire. Solder one end to terminal 9 of SW2.

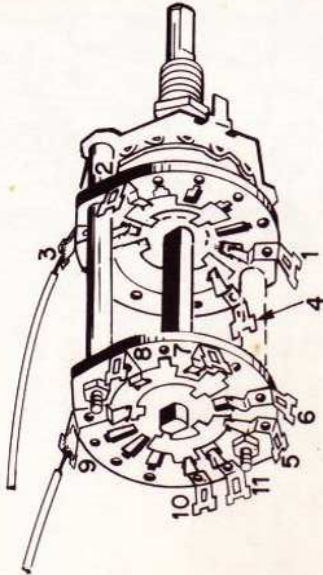

FIGURE 10

## FIRST WIRING—TOP OF CHASSIS

SEE FIGURE 11

- Red wire. Solder one end to terminal 1 of C16. Connect the other end to terminal 2 of C16.
- Red wire. Solder one end to terminal 1 of C15. Connect the other end to terminal 2 of C15.
- Red wire. From power transformer through grommet 2. Connect to terminal 2 of TS-12.
- Violet wire through grommet 2. Connect to terminal 2 of TS-9.
- Green wire through grommet 2. Connect to terminal 4 of TS-9.
- C13, .005  $\mu$ f, disc capacitor. Connect one lead to terminal 1 of TS-12. Insert other lead in center hole of TS-12 as shown in Figure 11.

12

- Orange wire. Insert one end in center hole of TS-12 and solder (2 wires). The other end will be connected later.
- R26, 20 $\Omega$ , 10-watt resistor (square shaped). Solder one lead to terminal 2 of TS-12 (2 wires). Connect the other lead to terminal 5 of TS-9. Place resistor flat against chassis.
- R27, 150K resistor (brown, green, yellow). Connect one lead to terminal 1 of TS9. Connect the other lead to terminal 5 of TS-9.
- Gray wire through grommet 2. Connect to terminal 1 of TS-12.
- RFC3, 5 millihenry (mh) choke. Solder one lead to terminal 1 of TS-12 (3 wires). Connect other lead to terminal 3 of TS-1.
- C14, .005  $\mu$ f, disc capacitor. Solder one lead to terminal 3 of TS-1 (2 wires). Connect the other lead to terminal 1 of TS-1.
- Red wire. Solder one end to terminal 2 of C15 (2 wires). Solder the other end to terminal 1 of TS-1 (2 wires).

- Preparation of plate lead with parasitic choke L7. See Figure 12. Cut one lead of parasitic choke (8 turns on a 100 $\Omega$  resistor),  $\frac{1}{2}$ " long and solder to spring plate clip. Cut the other lead  $1\frac{3}{4}$ " long and slip a  $1\frac{3}{8}$ " piece of black tubing onto this lead. Solder to terminal 3 of TS-1.



FIGURE 12

## PREWIRING OF TANK COIL L6

SEE FIGURE 13

- Two yellow wires and one orange wire. Solder one end of each wire to terminal 1 of L6 (3 wires).
- White wire with black tracer. Solder one end to terminal 2.
- Yellow wire. Solder one end to terminal 3.
- White wire with red tracer ( $4\frac{1}{4}$ " long). Solder one end to terminal 4.







## PREWIRING OF TANK COIL L6

- White wire with orange tracer. Solder one end to terminal 5.
- Green wire. Connect one end to terminal 6.

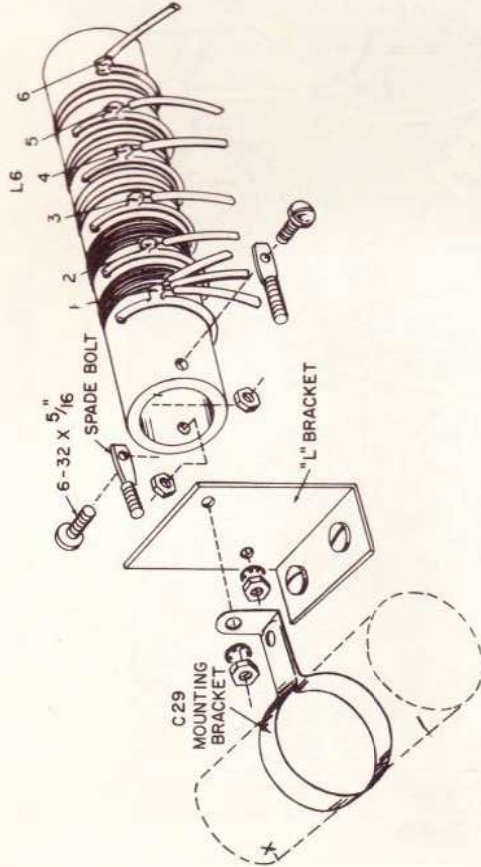

FIGURE 13

## MOUNTING TANK COIL L6 AND CAPACITOR C29

- Fasten spade bolts to ceramic form of L6. See Figure 13. Note position of spade bolts. Use  $6-32 \times \frac{5}{16}$  screws and nuts. Insert screw through hole in spade bolts, then through hole in ceramic coil form.
- Mount L6 and C29 ( $20\mu\text{f}$ , 600V capacitor) on "L" bracket. See Figure 13. Note position of terminals on L6. They should point to rear of chassis. Insert spade bolts in holes in "L" bracket. Put lockwasher and nut on bolt nearer C16 and tighten nut securely. Note angle of clamp on C29. The red lead should point to C16. Put C29 bracket over other spade bolt. Use lockwasher and nut, and tighten.
- Solder black wire on capacitor to C29 mounting bracket. See Figures 11 and 13.
- Pass red wire on C29 through grommet 4. This will be connected later.
- Yellow wires on terminal 1 of L6. Solder one wire to terminal 2 of C16 (2 wires). Pass the other yellow wire through grommet 5. This will be connected later.

- Pass all remaining wires on L6 through grommet 3. They will be connected later.
- L8, 2-turn coil. Solder one end to terminal 6 of L6 (2 wires). Solder the other end to terminal 1 of TS-1.

## SILICON RECTIFIERS

- SR2, silicon rectifier. Cut leads to  $\frac{3}{4}$ ". Connect the positive (+) lead (banded end) to terminal 5 of TS-9. Observe polarity as shown in Figure 11. Solder the Negative (-) lead to terminal 3 of TS-9. Soldering silicon rectifiers calls for protection from heat. Hold the lead near the body of the rectifier with long-nose pliers while soldering. Hold lead till solder hardens and cools.
- SR1, silicon rectifier. Cut leads to 1". Solder negative (-) lead (end without band) to terminal 5 of TS-9 (4 wires). Solder the positive (+) lead to terminal 2 of TS-9 (2 wires).

## SECOND WIRING—CHASSIS BOTTOM

SEE FIGURE 14

- White wire. Solder one end to terminal 3 of J3 (3 wires). Solder the other end to pin 5 of J2.
- Blue wire. Solder one end to pin 7 of J4. Connect the other end to terminal 2 of TS-7.
- White wire with red tracer. Connect one end to terminal 4 of TS-8. Solder the other end to terminal 6 of TS-5 (2 wires).
- C28,  $40\mu\text{f}$ , 350V capacitor. Solder the positive (+) lead to terminal 1 of TS-2 (2 wires). Solder the other lead to terminal 2 of TS-8 (2 wires).
- C27,  $40\mu\text{f}$ , 350V capacitor. Solder the positive (+) lead to terminal 4 of TS-8 (3 wires). Solder the other lead to terminal 2 of TS-2 (4 wires).
- Gray wire. Connect one end to terminal 3 of TS-2. Solder the other end to pin 8 of J2.
- RFC5, 2.2  $\mu\text{h}$ , line filter choke (wound on  $\frac{1}{4}$ " diameter coil form). Cut both leads to  $\frac{3}{4}$ ". Connect one lead to terminal 1 of TS-3. Connect the other lead to terminal 1 of TS-4.



SECOND WIRING—CHASSIS BOTTOM

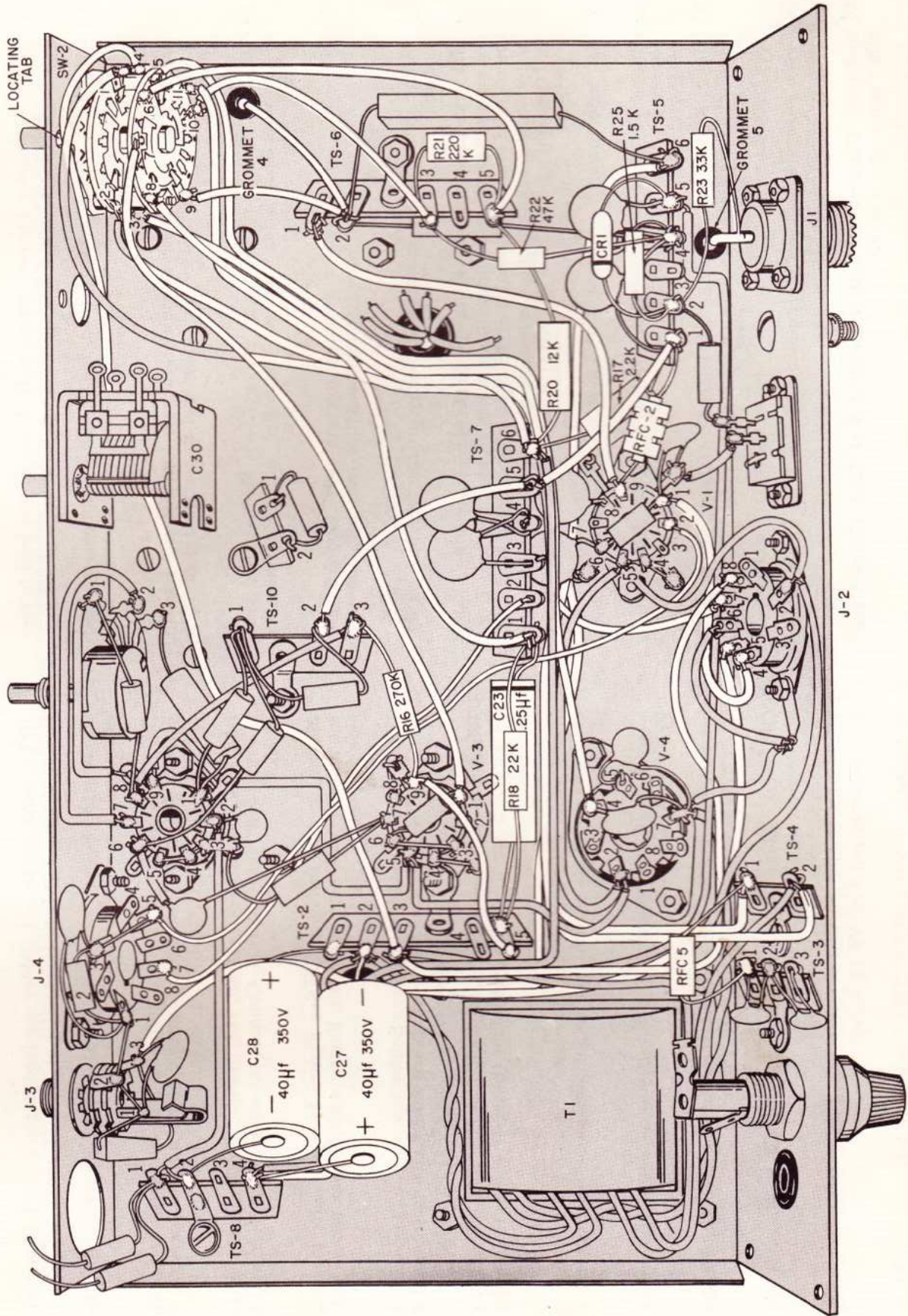

FIGURE 14



## SECOND WIRING—CHASSIS BOTTOM

- Yellow wire. Solder one end to pin 1 of V1 (3 wires). Connect the other end to pin 4 of J2.
- R25, 1.5K resistor (brown, green, red). Connect one lead to terminal 2 of TS-5. Connect the other lead to terminal 4 of TS-5.
- R20, 12K, 2-watt resistor (brown, red, orange). Connect one lead to terminal 6 of TS-7. Connect the other lead to terminal 5 of TS-6.
- R22, 47K resistor (yellow, violet, orange). Connect one lead to terminal 3 of TS-6. Solder the other lead to terminal 4 of TS-5 (4 wires).
- R21, 220K, 1-watt resistor (red, red, yellow). Connect one lead to terminal 3 of TS-6. Connect the other lead to terminal 5 of TS-6.
- R23, 3.3K, 1-watt resistor (orange, orange, red). Connect one lead to terminal 2 of TS-5. Insert the other lead into the terminal on J1.
- Yellow wire through grommet 5. Solder in the terminal on J1 (2 wires).
- CR1, crystal diode. One end of the diode is marked with a color dot or band or other distinguishing mark. Solder the lead from the marked end to terminal 2 of TS-5 (4 wires). Hold lead with long-nose pliers to prevent overheating of diode. Solder the other lead to terminal 5 of TS-5 (3 wires). Observe same precautions to protect diode from heat.
- Red wire through grommet 4. Connect to terminal 2 of TS-6.
- Orange wire. Connect one end to terminal 5 of TS-7. Connect the other end to terminal 1 of TS-5.
- R17, 2.2K, 3-watt resistor (square shaped). Connect one lead to terminal 6 of TS-7. Place resistor flush against chassis. Connect the other lead to terminal 1 of TS-5.
- Green wire. Connect one end to terminal 1 of TS-6. Connect the other end to pin 9 of V1.
- Red wire. Connect one end to terminal 5 of TS-2. Connect the other end to pin 9 of V3.
- R16, 270K resistor (red, violet, yellow). Solder one lead to pin 9 of V3 (2 wires). Solder the other lead to terminal 3 of TS-10 (2 wires).
- Orange wire. Solder one end to terminal 2 of TS-10 (2 wires). Connect the other end to terminal 5 of TS-7.
- RFC2, 5 mh, choke coil. Solder one lead to pin 9 of V1 (2 wires). Solder the other lead to terminal 1 of TS-5 (4 wires).
- Violet wire. Solder one end to pin 5 of J4 (2 wires). Solder the other end to pin 2 of V1.
- C23, .25  $\mu$ f, 400V tubular capacitor. Connect lead from end with band to terminal 1 of TS-7. Connect other lead to terminal 5 of TS-2.
- R18, 22K, 2-watt resistor (red, red, orange). Solder one lead to terminal 5 of TS-2 (3 wires). Connect the other lead to terminal 1 of TS-7.
- Mount function switch SW2. See Figure 14. Make sure locating tab fits into small hole in chassis. Fasten with  $\frac{3}{8}$ " hex nut on outside of chassis.
- White wire with brown tracer. Solder one end to terminal 3 of TS-2 (3 wires). Route wire as shown under C30 to terminal 4 of SW2, and solder. See Figure 10 for location of terminal 4.
- White wire with red tracer. Solder one end to terminal 1 of TS-4 (2 wires). Route as shown and solder the other end to terminal 1 of SW2.
- White wire with red tracer. Connect one end to terminal 2 of TS-4. Route as shown and solder other end to terminal 2 of SW2.
- Gray wire from terminal 3 of SW2. Route as shown and solder to pin 7 of J2.
- Orange wire. Solder one end to terminal 10 of SW2. Solder the other end to terminal 3 of TS-6 (3 wires).
- Gray wire. Solder one end to terminal 11 of SW2. Route as shown and connect to terminal 1 of TS-7.
- White wire. Solder one end to terminal 5 of SW2. Route as shown and solder to pin 4 of V4 (2 wires).
- Red wire from terminal 9 of SW2. Connect to terminal 2 of TS-6.
- Green wire. Solder one end to terminal 6 of SW2. Solder the other end to terminal 5 of TS-6 (3 wires).



SECOND WIRING — BOTTOM

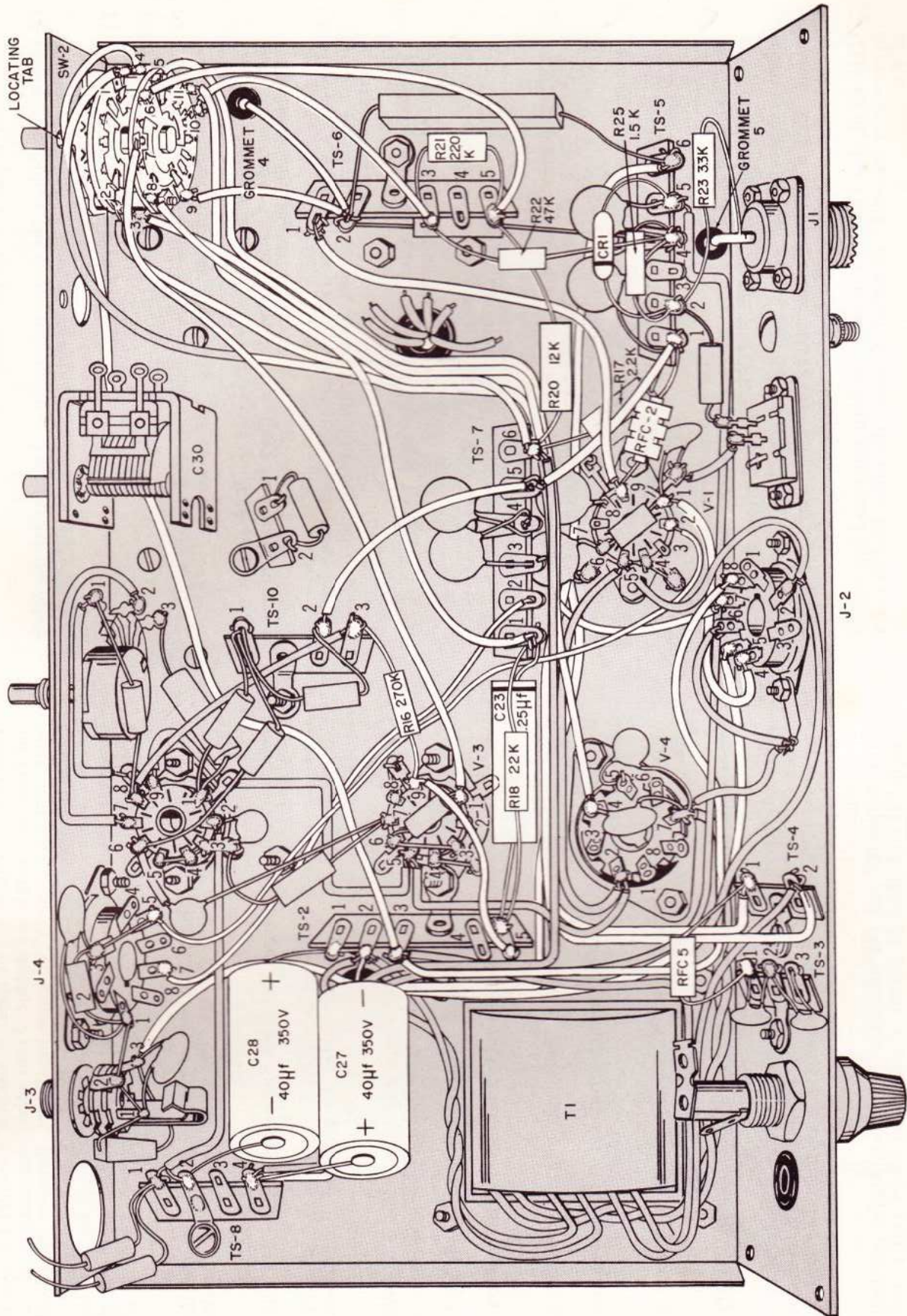

FIGURE 14



## SECOND WIRING—CHASSIS BOTTOM

- Gray wire. Solder one end to terminal 7 of SW2. Route as shown and solder to pin 1 of V3 (2 wires).
- Green wire. Solder one end to terminal 8 of SW2. Solder the other end to terminal 6 of TS-7 (4 wires).

## THIRD WIRING—BOTTOM

### SEE FIGURE 15

- White wire with brown tracer. Solder one end to pin 3 of J2. Solder the other end to terminal 2 of TS-6 (5 wires).
- C20, .1  $\mu$ f, 400V, tubular capacitor. Connect the lead on end with band to terminal 4 of TS-7. Solder the other lead to terminal 1 of TS-10 (4 wires).
- R19, 22K, 1-watt resistor (red, red, orange). Solder one lead to pin 6 of J2 (2 wires). Solder the other lead to terminal 1 of TS-7 (4 wires).
- C5, .005  $\mu$ f, disc capacitor. Connect one lead to pin 3 of V1. Connect the other lead to pin 7 of V1.
- R2, 100K resistor (brown, black, yellow). Solder one lead to pin 7 of V1 (2 wires). Solder the other lead to terminal 4 of TS-7 (4 wires).
- R5, 8.2K, 2-watt resistor (gray, red, red). Solder one lead to terminal 5 of TS-7 (4 wires). Connect the other lead to terminal 3 of TS-7.
- R4, 10K, 1-watt resistor (brown, black, orange). Solder one lead to pin 8 of V1 (2 wires). Connect the other lead to terminal 3 of TS-7.
- C2, .005  $\mu$ f, disc capacitor. Solder one lead to terminal 2 of TS-7 (2 wires). Cut a piece of black tubing  $\frac{7}{8}$ " long. Slip it over the other lead and connect to pin 3 of V1.
- RFC1, 5 mh, RF coil. Solder one lead to terminal 3 of TS-7 (4 wires). Cut a piece of black tubing  $\frac{5}{8}$ " long. Slip it over the other lead and solder to pin 3 of V1 (3 wires).
- C11, .05  $\mu$ f, disc capacitor. Solder one lead to ground lug bolted to accessory socket J2 (3 wires). Connect the other lead to pin 8 of V4.
- RFC4, .5 mh RF coil. Cut a piece of black tubing  $\frac{1}{2}$ " long. Slip it over one lead and solder to pin 8 of V4 (2 wires). Solder the other lead to pin 4 of J2 (2 wires).

- 4 $\frac{3}{4}$ " shielded cable. From one end of the cable, remove  $\frac{3}{4}$ " of outer insulation and  $\frac{1}{4}$ " of inner insulation. Unravel the shield and twist into single conductor. From other end, remove  $\frac{1}{2}$ " of outer insulation and  $\frac{1}{4}$ " of inner insulation. Remove the shield wire at this end.  
Solder the end of the cable without the shield to pin 5 of V4 (2 wires). At the other end, solder the shield to terminal 1 of TS-11 (2 wires). Connect the inner conductor to terminal 2 of TS-11.
- Band switch SW3. Mount to front of chassis. Make sure the locating tab on the switch fits into the small hole in the chassis. Fasten with  $\frac{3}{8}$ " nut.
- Orange wire from terminal 5 of SW3. Solder to terminal 2 of C30.
- L5, 1.6  $\mu$ h, RF coil. One lead is soldered to terminal 9 of SW3. Cut other lead  $\frac{3}{4}$ " long and solder to terminal 2 of TS-11 (3 wires).
- C8, .005  $\mu$ f, disc capacitor. Solder one lead to terminal 5 of SW3 (3 wires). Solder the other lead to terminal 1 of TS-6 (2 wires).
- Orange wire through grommet 3. Solder to terminal 11 of SW3.
- White wire with black tracer through grommet 3. Solder to terminal 12 of SW3.
- Yellow wire through grommet 3. Solder to terminal 13 of SW3.
- White wire with red tracer through grommet 3. Solder to terminal 14 of SW3.
- White wire with orange tracer through grommet 3. Solder to terminal 15 of SW3.
- Green wire through grommet 3. Solder to terminal 16 of SW3.
- Line cord. Insert cord through grommet 1 from outside of rear chassis. Tie a knot in the cord  $2\frac{1}{2}$ " from end of wires. Solder one lead to terminal 1 of TS-3 (3 wires). Solder the other lead to terminal 1 of fuse holder.
- RFC6, 2.2  $\mu$ h RF coil ( $\frac{1}{4}$ " diameter coil form). Solder one lead to terminal 2 of TS-4 (3 wires). Connect the other lead to terminal 3 of TS-3.
- $1\frac{1}{4}$ " bare wire. Solder one end to terminal 2 on fuse holder. Solder the other end to terminal 3 of TS-3 (3 wires).



# THIRD WIRING — BOTTOM

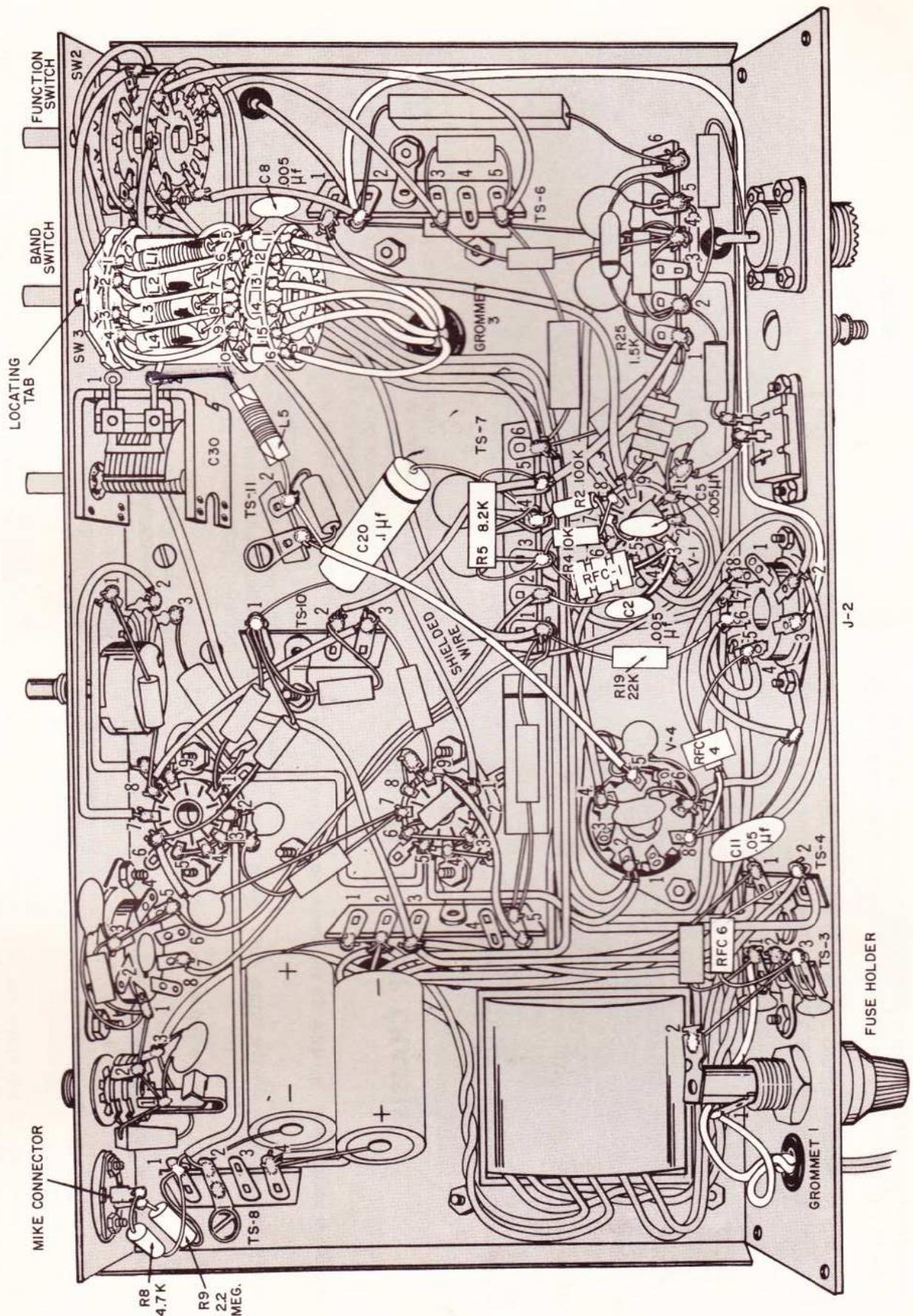

FIGURE 15



SEE FIGURE 16

- ☑ Mike connector. Insert connector through hole in front panel from backside. Note position of terminals. Use two 2-56  $\times$   $\frac{1}{4}$ " screws and nuts.
- ☑ Power output meter. See Figure 16. Insert meter through hole on front side of front panel. Take rectangular mounting clip and slip over meter body from backside of panel, make sure the meter is in correct position. Do not mount meter upside down. Place meter face on soft surface and push clip down with fingers until meter is secure.
- ☑ Red, flat-faced pilot light. See Figure 16. Insert light through hole on front side of front panel. Slip small square mounting clip over the light body. Place face of light on soft surface, and push clip down with screwdriver till light is secure.
- ☑ Front panel. Fit the front panel to the front of the chassis by lining up the holes in the panel with the shafts of the controls. Place a flat washer over the key jack and loosely fasten with a  $\frac{3}{8}$ " nut. Place a  $\frac{3}{8}$ " nut over the gain control, band switch, and function switch. Make sure the panel is square with the chassis and that the shafts of the controls are not binding at the panel. Tighten all nuts.

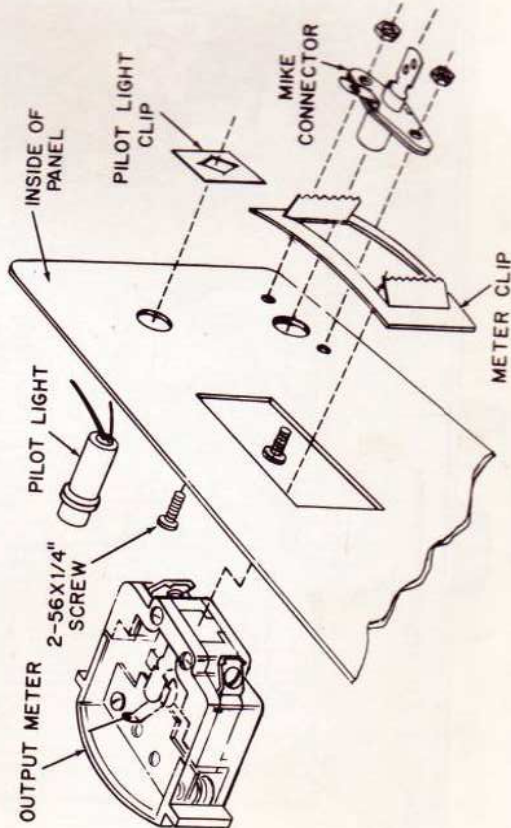

FIGURE 16

- ☑ GAIN CONTROL knob. Turn the shafts of all the controls fully counterclockwise. Place a small knob over the GAIN control and tighten the set screw when the white dot on the knob is in line with "0" on the panel.
- ☑ DRIVE TUNE knob. Line the white dot up with "0" and tighten set screw.
- ☑ BAND knob. Line the white dot up with "80" and tighten set screw.
- ☑ FUNCTION knob. Line white dot up with "OFF" and tighten set screw.
- ☑ PLATE TUNE knob. Line white dot up with "0" and tighten set screw.
- ☑ LOAD knob. Line white dot up with "0" and tighten set screw.

SECOND WIRING — TOP CHASSIS

SEE FIGURE 17

- ☑ Orange wire from the center hole of TS-12. Slip the bare end of the wire under the screw head of the + terminal on the meter. Tighten screw.
- ☑ White wire with blue tracer from grommet 2. Similarly fasten this wire to the - terminal on the meter.
- ☑ 1 $\frac{3}{4}$ " black tubing. Slip the tubing over one of the leads from the red pilot light. Solder this lead to terminal 4 of TS-9 (2 wires). Cut the other lead to 1" and solder to terminal 1 of TS-9 (2 wires).

MIKE CONNECTOR WIRING

SEE FIGURE 15

- ☑ R-8, 4.7K resistor (yellow, violet, orange) from terminal 1 of TS-8. Solder the free lead to the center terminal of the mike connector.
- ☑ R-9, 2.2 meg resistor (red, red, green) from terminal 1 of TS-8. Solder the free lead to the ground terminal of the mike connector.



# SECOND WIRING—TOP CHASSIS

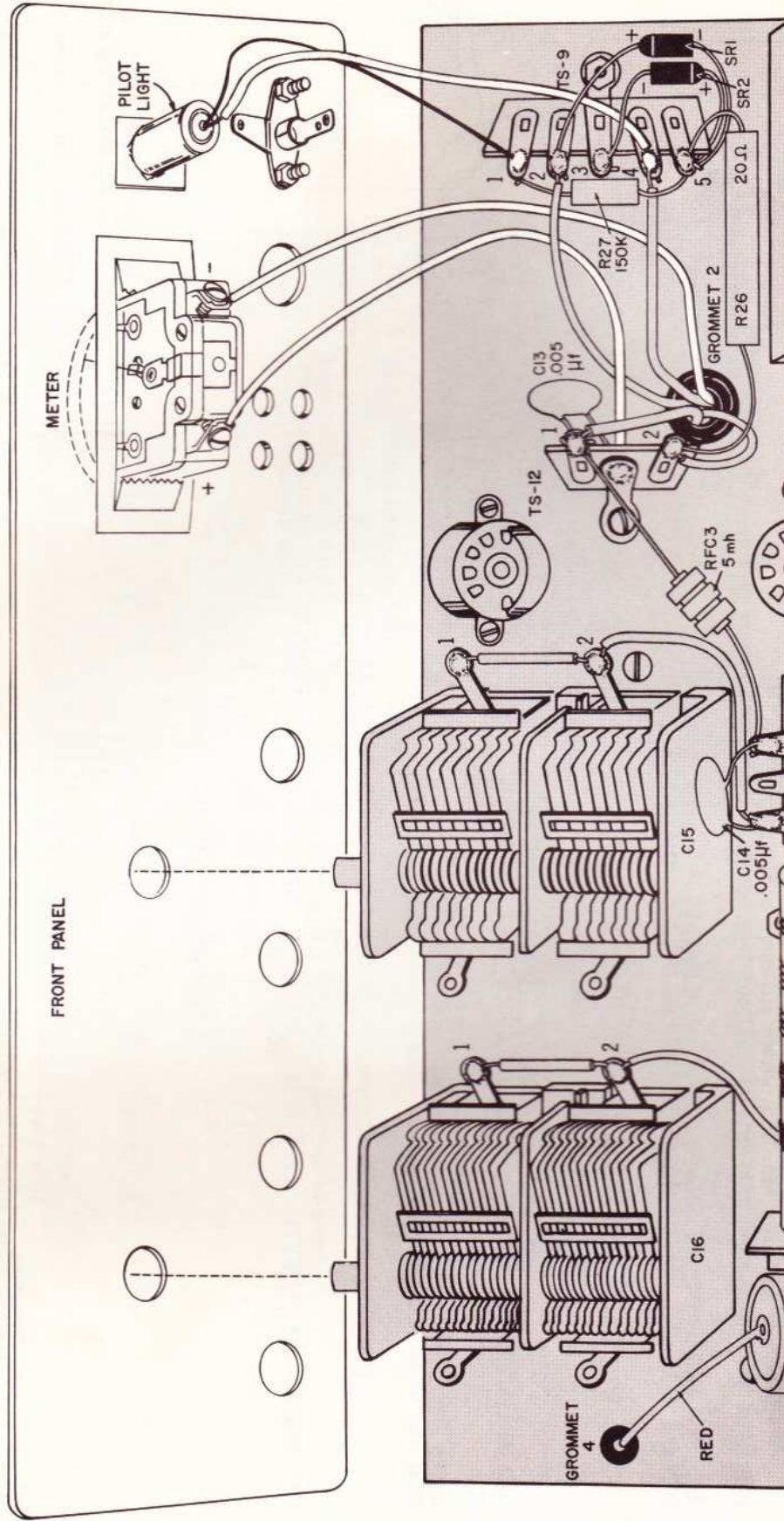

FIGURE 17



## ACCESSORY PLUG WIRING

SEE FIGURE 18

- ✓ Remove cover from plug. Cut a 2½" length of bare wire and form as shown. Insert the ends of the wire in pins 4 and 5 of the accessory plug. Solder both pins. Remove any excess wire. Replace cover on plug.
- ✓ Insert this plug in J2 accessory socket.
- ✓ Insert 3 amp fuse in fuse holder.

This completes the wiring of your kit. Carefully inspect your work for unsoldered connections and poor solder joints.

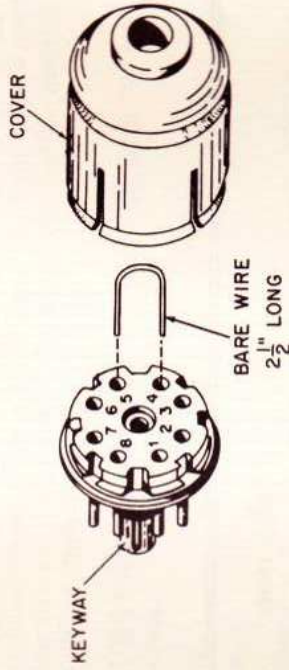

FIGURE 18

## FINAL ASSEMBLY

SEE FIGURE 19

- ✓ Carefully insert V-1 (6HF8), V-2 (12AX7), V-3 (6DR7) and V-4 (6DQ6B) in their respective sockets.
- ✓ Connect the plate connector to the metal cap on V-4.
- ✓ If you have an ohmmeter, check resistance values at the tube pins. The readings you receive should be reasonably close to the value indicated in the resistance chart.

**CAUTION: THIS TRANSMITTER WILL BE DAMAGED IF OPERATED WITHOUT A PROPER LOAD.**

- ✓ Connect the antenna to J-1.
- ✓ Turn FUNCTION switch to **STANDBY**.

**CAUTION: HIGH VOLTAGE IS PRESENT. DO NOT TOUCH ANY OF THE WIRING WHILE THE TRANSMITTER IS ON.**

- ✓ Plug the line cord into a 110V AC outlet. The red pilot light and tube filaments should light up. Turn the power off.
- ✓ Disconnect the antenna and remove the line cord from the power line.
- ✓ Fasten the four rubber feet to the bottom of the cabinet with four sheet metal screws.

Pull the line cord through the opening in the rear of the cabinet and push the chassis flush against the back of the cabinet. Fasten with four sheet-metal screws.

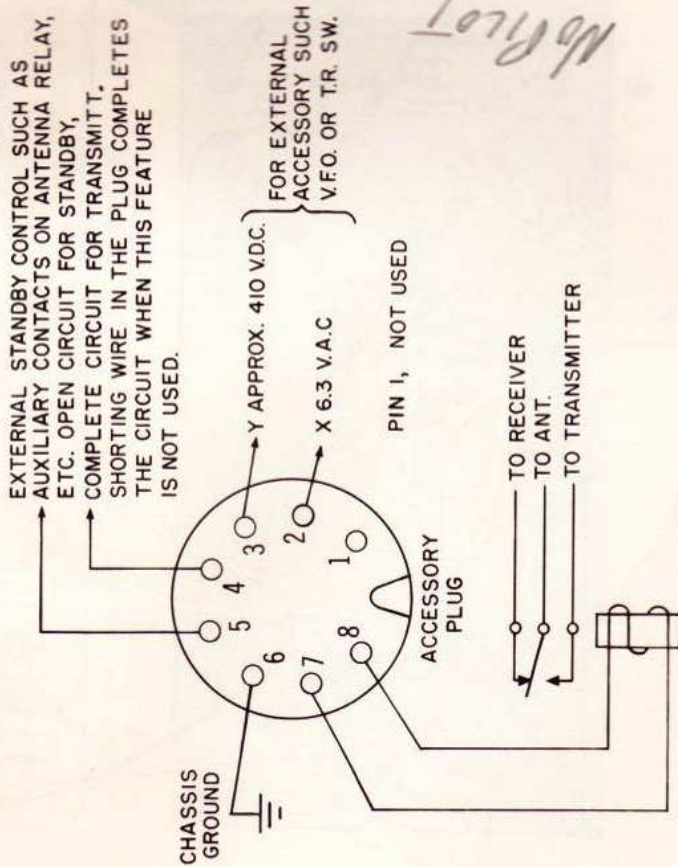

AN ANTENNA, OR OTHER CONTROL RELAY MAY BE CONNECTED TO PINS 7 AND 8 OF THE ACCESSORY RECEPTACLE. WHEN THE FUNCTION SWITCH IS IN THE "TUNE", "AM", OR "C.W." POSITIONS, 117 V.A.C. IS INTERNALLY CONNECTED TO THESE PINS AND EXTERNAL RELAY IS ENERGIZED.

**INSTRUCTIONS FOR WIRING ACCESSORIES TO PLUG.**



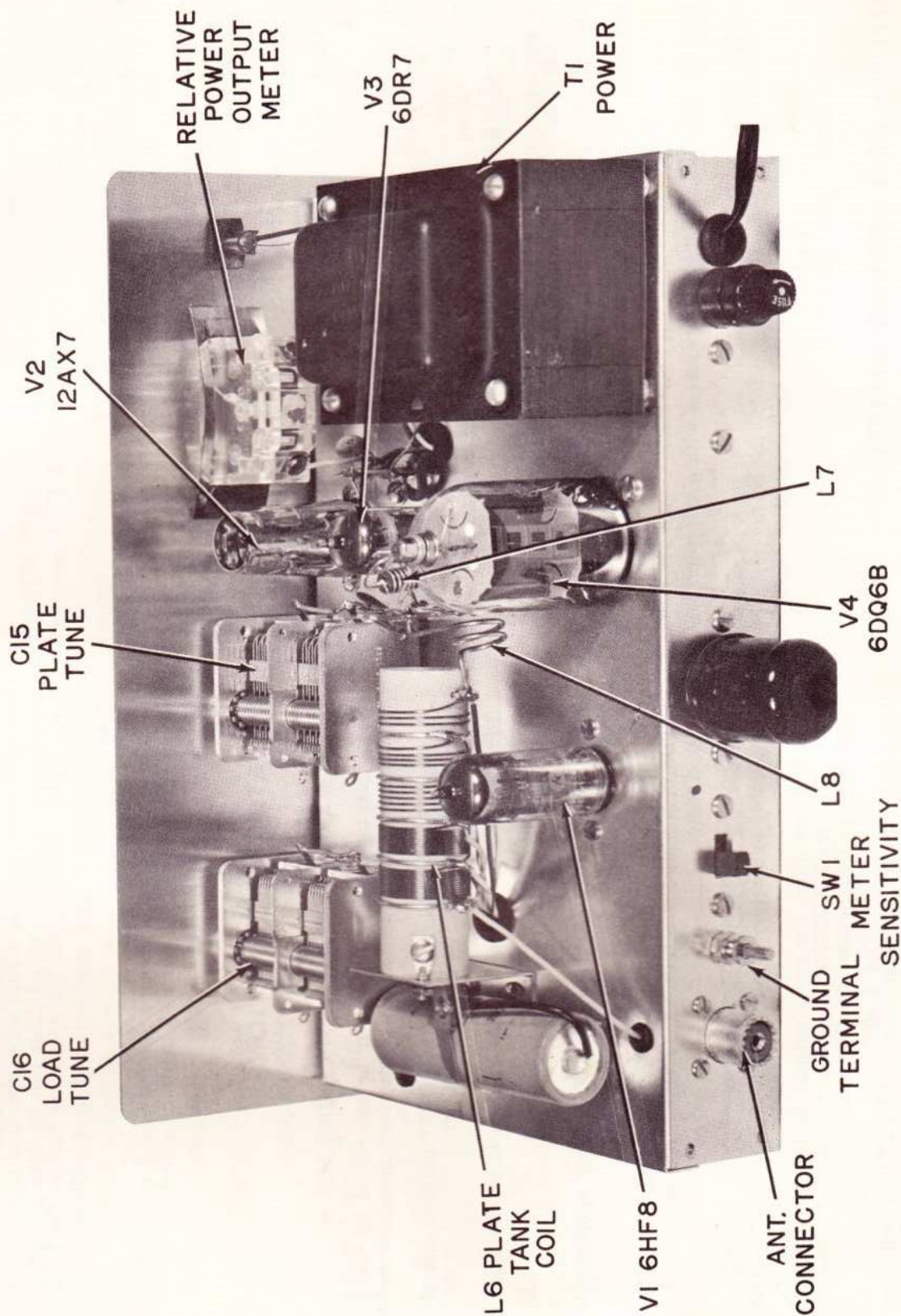

FIGURE 19



## CONTROL ACTIONS

**MIC:** Microphone input jack for crystal microphone.

**KEY:** Telegraph key input jack. Used for CW operation.

**XTAL:** Crystal input. Accepts crystal cut for desired transmitting frequency (80 to 6 meters).

**VFO:** Variable frequency oscillator input. If desired, VFO operation can be used in place of crystal.

**GAIN:** Audio volume control. Controls amount of carrier modulation.

**DRIVE TUNE:** Matches the output impedance of VIB to the input impedance of V4. Use this control in conjunction with the PLATE TUNE and LOAD controls when tuning the transmitter.

**BAND:** Selects the band of frequencies at which you wish to transmit.

**PLATE TUNE:** Resonates the output Pi network to the operating frequency.

**LOAD:** Matches the impedance of the antenna to the output of V4. Will match antennas ranging from 40 to 600 ohms.

**FUNCTION:**

**OFF:** Turns power ON or OFF.

**TUNE:** Use this position when tuning transmitter.

**AM:** Use this position for voice transmission.

**STANDBY:** Turn to this position when receiving a reply to a transmission.

**CW:** Use this position for CW operation with a telegraph key.

**METER SENSITIVITY:** This switch, located on back of chassis, reduces the sensitivity of the meter to accommodate high-impedance antenna loads,

## ANTENNA AND GROUND SYSTEMS

A well-designed antenna is a must for optimum results. The PI network in the T-60 makes it possible to match most antennas (40 to 600 ohms). Detailed information on the subject of antennas is too

broad to be covered in this manual. We recommend you refer to the *Radio Operator's Handbook (ARRL)* or other similar publications for information on antenna systems.

If the transmitter is to be terminated in any type of single conductor load or antenna, such as a long wire type, it is imperative that the chassis receive a good ground. This can be done by connecting a heavy gauge wire between the grounding bolt at the back of the chassis and a water pipe or ground rod sunk eight feet or more in the earth.

For properly terminated lines, a ground is not essential, but it is recommended because it acts as a lightning arrester.

## OPERATING INSTRUCTIONS

### TUNING PROCEDURE

**NOTE:** You must have an amateur license issued by the Federal Communications Commission to operate this transmitter on the air.

1. Set the **FUNCTION** switch in the "OFF" position and plug the line cord into a 117V, 60 cycle, AC outlet.
2. Plug the desired crystal into the receptacle on the front panel.
3. Set **BAND** switch to the desired band.
4. Turn **FUNCTION** switch to "TUNE." Allow approximately 30 seconds for unit to warm up.
5. Simultaneously adjust the **DRIVE TUNE**, **PLATE TUNE**, and **LOAD** controls for maximum deflection on the relative power output meter.
6. Rotate the **FUNCTION** switch to "CW." Repeat Step 5 as quickly as possible and return the **FUNCTION** switch to "STANDBY."
7. For CW operation, the key plug may be inserted into the **KEY** jack. With the **FUNCTION** switch in the "CW" position, the key may now be manipulated for CW transmission.

8. For AM (phone) operation, turn the **FUNCTION** switch to "AM" after following the tuning procedure up to Step 6. Speak directly into the microphone for best audio reports. With an average low-priced microphone, the **GAIN** control will be approximately at 3 and the meter will indicate a considerable amount of modulation.



**NOTE:** The tune-up is the same for AM or CW operation—ALWAYS load in the CW position, switching to AM to make phone transmission. The "TUNE" position is used only for preliminary tune-up to prevent damage to the output tube should considerable time be required to find the proper settings of the controls.

## VFO OPERATION (VARIABLE FREQUENCY OSCILLATOR)

Remove the crystal from the XTAL socket. Insert the VFO output plug into the VFO socket making sure the grounded side of the plug is to the left as you face the transmitter. Set the BAND switch to correspond to the frequency of the VFO, or a multiple thereof.

Follow the tuning procedure as outlined previously.

**DO NOT KEY THE VFO FOR CW OPERATION.**

## FREQUENCY COVERAGE

The chart below lists the recommended frequencies of operation for the different bands.

Band (Meters)	Frequency of Crystal or VFO (MC)	Transmitter Freq. Range (MC)
80	3.5 to 4.0	3.5 to 4.0
40	7.0 to 7.3	7.0 to 7.3
20	7.0 to 7.175	14.0 to 14.35
15	7.0 to 7.150	21.0 to 21.45
10	7.0 to 7.425	28.0 to 29.7
6	8.334 to 9.0	50.0 to 54.0

From the above information, you can select the crystals for the bands in which you wish to operate.

## SPECIFICATIONS

OUTPUT FREQUENCIES	3.5 - 4 MC 7.0 - 7.3 MC 14.0 - 14.35 MC 21.0 - 21.45 MC 28.0 - 29.7 MC 50 - 54 MC
--------------------	--------------------------------------------------------------------------------------------------

POWER INPUT TO FINAL AMPLIFIER 60 Watts Nominal

FREQUENCY CONTROL Crystal or External VFO

OUTPUT CIRCUIT PI-Network, 40-600 ohms, coax output connector

TUBES 6HF8 Crystal Oscillator-Multiplier  
6DQ6B Power Amplifier  
12AX7 Speech Amplifier  
6DR7 Modulator

MODULATION Controlled Carrier, Screen Modulation

VFO Operation The external VFO should be capable of supplying 8 to 10 volts across 56,000 ohms shunted by 25  $\mu\mu\text{f}$  capacity.

TVI REDUCTION The transmitter is fully shielded by its cabinet, thus assuring minimum harmonic radiation. Filtering and bypassing of AC and keying leads is provided, and generous bypassing of the meter and heater circuits is included.

MICROPHONE INPUT Accepts crystal microphone, front panel receptacle.

CW KEYING Panel mounted key jack accepts standard 2 connector  $\frac{1}{4}$ " plug.

TYPES OF EMISSION AM—Amplitude Modulation.  
CW—Continuous Wave

POWER SOURCE 105-125 Volts, 60 CPS, AC.

POWER CONSUMPTION 110 W Watts.

DIMENSIONS 5' High. 12" Wide. 7" Deep.

NET WEIGHT 12 lbs. (Approx.)



## THEORY OF OPERATION

The triode section of the 6HF8 (V1) operates as a modified Pierce oscillator when used with a crystal, and as an amplifier with an external V.F.O.

The signal voltage appearing at the plate of the triode section is then applied to the pentode section of the 6HF8 (V1). This section of the 6HF8 acts as a buffer, or a frequency multiplier, as required.

An adjustable pi network in the input circuit of the RF Output Amplifier, a 6DQ6B (V4), provides the proper coupling between the output of V1 and the input of V4. The RF Output Amplifier operates "straight through" on all bands except 6 meters, wherein it doubles.

Proper impedance matching of the antenna to the RF Output Amplifier (V4) is provided by a pi network in the output circuit. Antenna impedances from 40 to 600 ohms can be accommodated.

### CW OPERATION

The cathodes of the 6HF8 (V1) and the 6DQ6B (V4) are keyed for CW operations. To prevent excessive voltages at the key terminals, a 2200-ohm resistor is connected across the key jack. The voltage developed across this resistor also acts as a bias for the 6HF8 (V1) oscillator-buffer. During the "key-up" interval, tubes V1 and V4 are cut off. At the same time, the 6DQ6B is still drawing some current which helps stabilize the DC voltage supply.

If a V.F.O. is used for CW operation, the transmitter should be keyed, *not the V.F.O.*

### PHONE OPERATION

The output signal of the microphone is amplified by both sections of the 12AX7 (V2), and then applied to the first section of the 6DR7 (V3).

The first section of the 6DR7 is zero biased and thus, with modulation, grid rectification results causing the grid voltage to rise. This section, being direct-coupled to the grid of the following triode section, causes the cathode voltage of the 2nd section to vary at a rate proportional to the applied modulation. Capacitor C21 and resistor R14 determine the time constant at which this variation takes place.

A portion of the cathode voltage of the 2nd section of the 6DR7 is applied to the screen of the RF Output Amplifier (V4) when the Function switch is in the AM position. This voltage varies at an audio rate proportionally to the amount of modulation; thus, modulating the screen of the RF Output Amplifier (V4) while simultaneously increasing the average DC potential on the screen.

## POWER SUPPLY

Transformer T1 supplies 6.3 VAC for heating of tube filaments and a high AC voltage applied to rectifiers SR1 and SR2. Rectifiers SR1 and SR2 are connected in a full-wave voltage doubler circuit, supplying the high DC voltage necessary for proper operation of the transmitter.

## SERVICE HINTS

The proper operating voltages are found on the circuit diagram. The proper resistances are found in the resistance chart. Never measure resistances with the transmitter turned on.

TROUBLE	POSSIBLE CAUSE	SERVICE PROCEDURE
Blows fuse	Short in power supply. Function switch incorrectly wired.	Check resistance. Check wiring of silicon rectifiers. Check wiring of Function switch.
No meter reading	Bad crystal.	Replace crystal.
Meter reads backwards	Defective tube (6HF8). Incorrect wiring in oscillator circuit. CR1 defective.	Replace tube. Check wiring to 6HF8 tube. Replace CR1.
Tubes do not light	Meter leads reversed. CR1 wired backwards. Incorrect wiring of filaments. Fuse blown or defective.	Reverse meter leads. Check CR1 wiring. Check wiring of filaments. Replace fuse.



# PARTS LIST

Part Number

Description

## CAPACITORS

Symbol Number

C1	25 $\mu\mu\text{f}$ , disc	296015
C2	.005 $\mu\text{f}$ , disc	296000
C3	.005 $\mu\text{f}$ , disc	296000
C4	.005 $\mu\text{f}$ , disc	296000
C5	.005 $\mu\text{f}$ , disc	296000
C6	.005 $\mu\text{f}$ , disc	296000
C7	.005 $\mu\text{f}$ , disc	296000
C8	.005 $\mu\text{f}$ , disc	296000
C9	.005 $\mu\text{f}$ , disc	296062
C10	10 $\mu\mu\text{f}$ , disc	275506
C11	.05 $\mu\text{f}$ , disc	296000
C12	.005 $\mu\text{f}$ , disc	296000
C13	.005 $\mu\text{f}$ , disc	296000
C14	.005 $\mu\text{f}$ , disc	296000
C15	Variable capacitor	286051
C16	Variable capacitor	286052
C17	.005 $\mu\text{f}$ , disc	296000
C18	47 $\mu\mu\text{f}$ , disc	276479
C19	.01 $\mu\text{f}$ , tubular	245015
C20	1 $\mu\text{f}$ , tubular	245014
C21	.001 $\mu\text{f}$ , disc	276016
C22	.005 $\mu\text{f}$ , disc	296000
C23	.25 $\mu\text{f}$ , tubular	295003
C24	.005 $\mu\text{f}$ , disc	296000
C25	.001 $\mu\text{f}$ , disc	276016
C26	.001 $\mu\text{f}$ , disc	209051
C27	40 $\mu\text{f}$ , electrolytic 350 v	209051
C28	40 $\mu\text{f}$ , electrolytic 350 v	209051
C29	20 $\mu\text{f}$ , electrolytic 600 v	207200
C30	Variable capacitor	286053

## COILS

L1	90 $\mu\text{h}$ , orange dot	162155
L2	90 $\mu\text{h}$ , yellow dot	162154
L3	3.3 $\mu\text{h}$ , red dot	162153
L4	1.5 $\mu\text{h}$ , blue dot	162152
L5	1.6 $\mu\text{h}$	162151
L6	Tank coil	152151
L7	Parasitic choke	162002
L8	6-meter coil	152152

## RESISTORS

R1	56K	301563
R2	100K	301104

## SERVICE PROCEDURE

Check connection to ground.  
 Check connections to antenna.  
 Turn up gain control.  
 Check setting of switch.  
 Replace defective tubes.  
 Check mike connection.  
 Check ground connection.  
 Make sure chassis is tightly secured to cabinet.  
 Separate antennas until no interference is present.

## POSSIBLE CAUSE

Poor ground connection.  
 Bad antenna connection.  
 Gain control not turned up.  
 Function switch set incorrectly.  
 Defective 12AX7 or 6DR7.  
 Bad mike connection.  
 Poor ground connection.  
 Poor bond between chassis and cabinet.  
 Transmitting antenna too close to TV antenna.

## TROUBLE

Erratic antenna loading  
 No modulation  
 Television interference

## RESISTANCE CHART

TUBE	PINS								
	1	2	3	4	5	6	7	8	9
V1 6HF8	0 $\Omega$	56K	25K	0 $\Omega$	.1 $\Omega$	470 $\Omega$	100K	40K	7K
V2 12AX7	800K	2M	0 $\Omega$	0 $\Omega$	0 $\Omega$	800K	*	470 $\Omega$	.1 $\Omega$
V3 6DR7	INF	NC	INF	0 $\Omega$	.1 $\Omega$	INF	10 meg	0 $\Omega$	40K
V4 6DQ6B	NC	.1 $\Omega$	NC	22K	47K	NC	0 $\Omega$	12 $\Omega$	top cap 15K

\* Will vary with setting of Gain control.  
 Resistance readings were taken with common lead of the ohmmeter connected to chassis.  
 FUNCTION switch in CW, and BAND switch in "80" position.



# PARTS LIST

Symbol Number	Description	Part Number	Symbol Number	Description	Part Number
<b>RESISTORS (Cont'd)</b>					
R3	470Ω	301471	SW1	Meter sensitivity	431003
R4	10K, 1 watt	304103	SW2	Function switch	437051
R5	8.2K, 2 watt	307822	SW3	Band switch	437052
R6	47K	301473	<b>TERMINAL STRIPS</b>		
R7	2.2K, 3-watt wirewound	370000	TS-1	3-terminal	442403
R8	4.7K	301472	TS-2	5-terminal	440502
R9	2.2 meg	301225	TS-3	3-terminal	440301
R10	470K	301474	TS-4	2-terminal	440201
R11	270K	301274	TS-5	6-terminal	440601
R12	470K	301474	TS-6	5-terminal	442952
R13	470Ω	301471	TS-7	6-terminal	440601
R14	10 meg	301106	TS-8	4-terminal	440401
R15	1 meg	301105	TS-9	5-terminal	440501
R16	270K	301274	TS-10	3-terminal	440302
R17	2.2K, 3-watt wirewound	370000	TS-11	2-terminal	440202
R18	22K, 2 watt	307223	TS-12	2-terminal	440201
R19	22K, 1 watt	304223	<b>TRANSFORMERS</b>		
R20	12K, 2 watt	307123	T1	Power transformer	107251
R21	220K, 1 watt	304224		Export power transformer	179051
R22	47K	301473	<b>TUBES</b>		
R23	3.3K, 1 watt	304332	V1	6HF8	614151
R24	100Ω	301101	V2	12AX7	611012
R25	1.5K	301152	V3	6DR7	611033
R26	20Ω, 10-watt wirewound	379051	V4	6DQ6B	614152
R27	150K	301154	<b>MISCELLANEOUS</b>		
R28	150Ω, 10-watt wirewound	379052		Bracket, "L"	470452
R29	150K, 2 watt	307154		Cabinet	702052
R30	100K control	392151		Chassis	463453
				Connector, mike	502220
				Fuse, 3 amp	491002
				Fuse holder	492200
				Grommet, 1/4"	830001
				Grommet, 1/2"	830002
				Instruction manual	750302
				Jack, key	509051
				Knob, large	761304
<b>RF CHOKES</b>					
RFC1	5 mh	161001			
RFC2	5 mh	161001			
RFC3	5 mh	161001			
RFC4	.5 mh	152042			
RFC5	2.2 μh	152005			
RFC6	2.2 μh	152005			
<b>RECTIFIERS AND DIODES</b>					
CR1	Diode	630007			
SR1	Silicon rectifier	630051			
SR2	Silicon rectifier	630051			



Description	Quantity	Part Number
<b>MISCELLANEOUS (Cont'd)</b>		
Knob, small	4	761004
Meter, output	1	659251
Panel, front	1	463452
Pilot light	1	644551
Plate cap	1	534052
Plug, accessory	1	502181
Receptacle, coaxial	1	502222
Rubber feet	4	831001
Shield, base	1	511001
Shield, 9-pin tube	1	510001
Socket, 9-pin molded	3	501190
Socket, octal	2	501180
Socket, octal for V4	1	509052

**HARDWARE**

Knurled nut, #8	1	572441
Lockwasher, 3/8"	1	582700
Lockwasher, #4	10	582200
Lockwasher, #6	29	582300
Lockwasher, #8	5	582400
Nut, 2-56	2	570000
Nut, 4-40	10	570220
Nut, 6-32	22	570340
Nut, 8-32	5	570440
Nut, 3/8"	8	570840
Screw, 2-56 x 1/4"	2	560002
Screw, 4-40 x 1/4"	10	560222
Screw, 6-32 x 1/4"	25	560342
Screw, 6-32 x 5/16"	2	560343
Screw, 6-32 x 1 1/4"	2	564341
Screw, 8-32 x 3/4"	1	560447
Screw, self-tapping, #6 x 5/16"	8	562393
Solder lug, #8	2	553002

Description	Quantity	Part Number
<b>HARDWARE (Cont'd)</b>		
Spade bolt, 6-32	2	568344
Spacer, metal	2	470085
Washer, flat metal	1	580702

**WIRE, SOLDER, AND TUBING**

Bare wire, 12"	1	806012
Cable, single-conductor shielded, 12"	1	803096
Line cord	1	802001
Solder, 10 ft.	1	930005
Tubing, black, 10"	1	812024
Wire, 2", red	12	801002
Wire, 3", orange	9	801003
Wire, 3 1/2", white/black	1	804093
Wire, 4", yellow	6	801004
Wire, 4 1/2", white/red	1	804091
Wire, 5", green	6	801005
Wire, 5", white/orange	1	804097
Wire, 6", blue	1	801006
Wire, 7", violet	1	801007
Wire, 8", gray	5	801008
Wire, 9", White	2	801009
Wire, 11", white/brown	2	801011
Wire, 12", white/red	3	801012
Wire, 16", white/blue	1	801016

**TOOLS NEEDED FOR CONSTRUCTION**

Stock Number	Description	Price*
46 N 852	Soldering iron, pencil type	\$5.78
50 N 132	Long-nose pliers, 6"	2.10
50 N 133	Diagonal cutters, 5"	1.84
45 N 378	Screwdriver, 6" with 1/4" blade	.64

\* Subject to change.



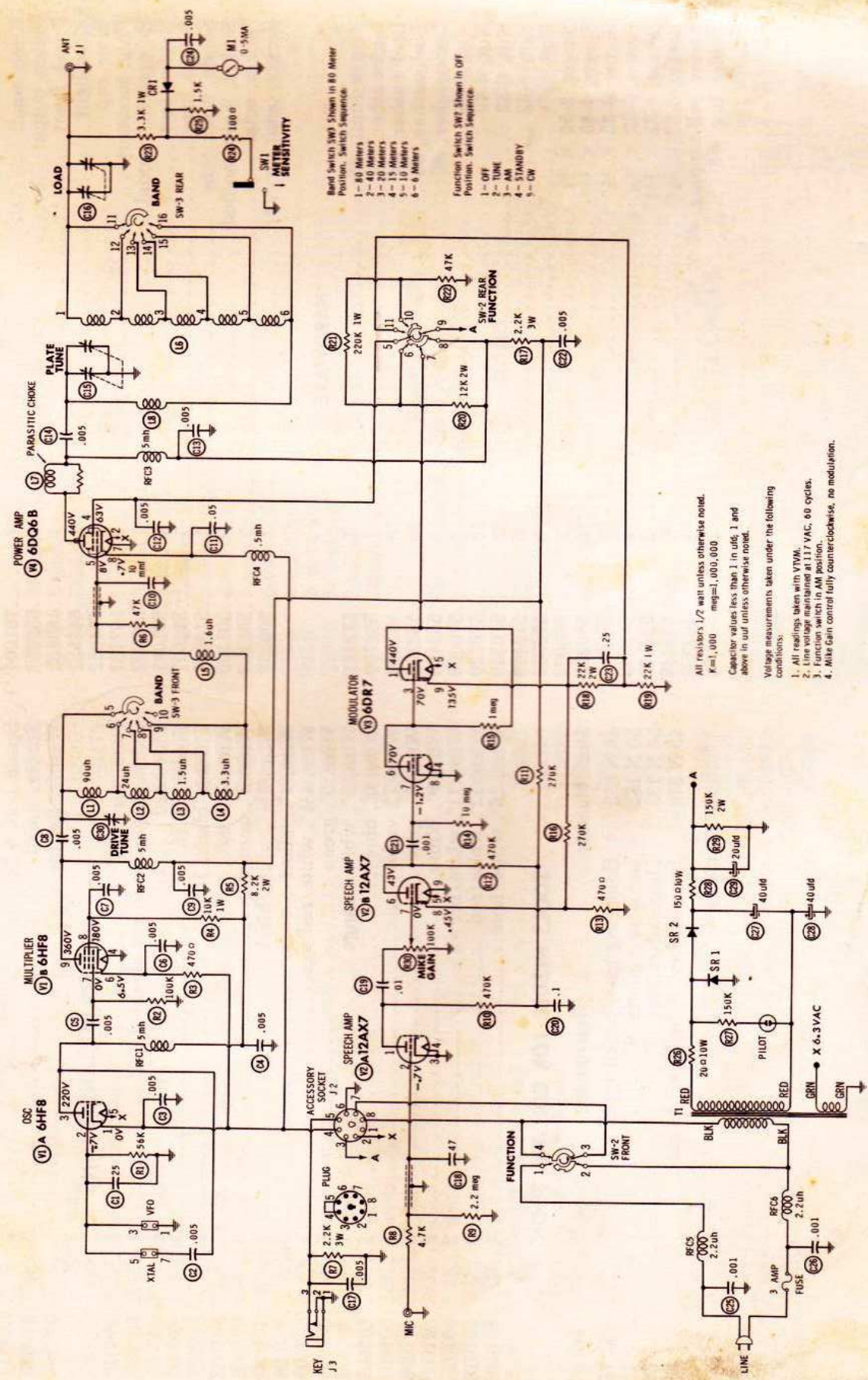

Band Switch SW3 Shown in 80 Meter Position. Switch Sequence

- 1-- 80 Meters
- 2-- 40 Meters
- 3-- 20 Meters
- 4-- 15 Meters
- 5-- 10 Meters
- 6-- 5 Meters

Function Switch SW2 Shown in Off Position. Switch Sequence

- 1-- OFF
- 2-- TUNE
- 3-- AM
- 4-- STANDBY
- 5-- CW

All resistors 1/2 watt unless otherwise noted.  
 K=1,000  
 mg=1,000,000  
 Capacitor values less than 1 in uuf, 1 and above in uf unless otherwise noted.

Voltage measurements taken under the following conditions:

1. All readings taken with VTVM.
2. Line voltage maintained at 117 VAC, 60 cycles.
3. Function switch in AM position.
4. Main gain control fully counterclockwise, no modulation.



# PARTS IDENTIFICATION

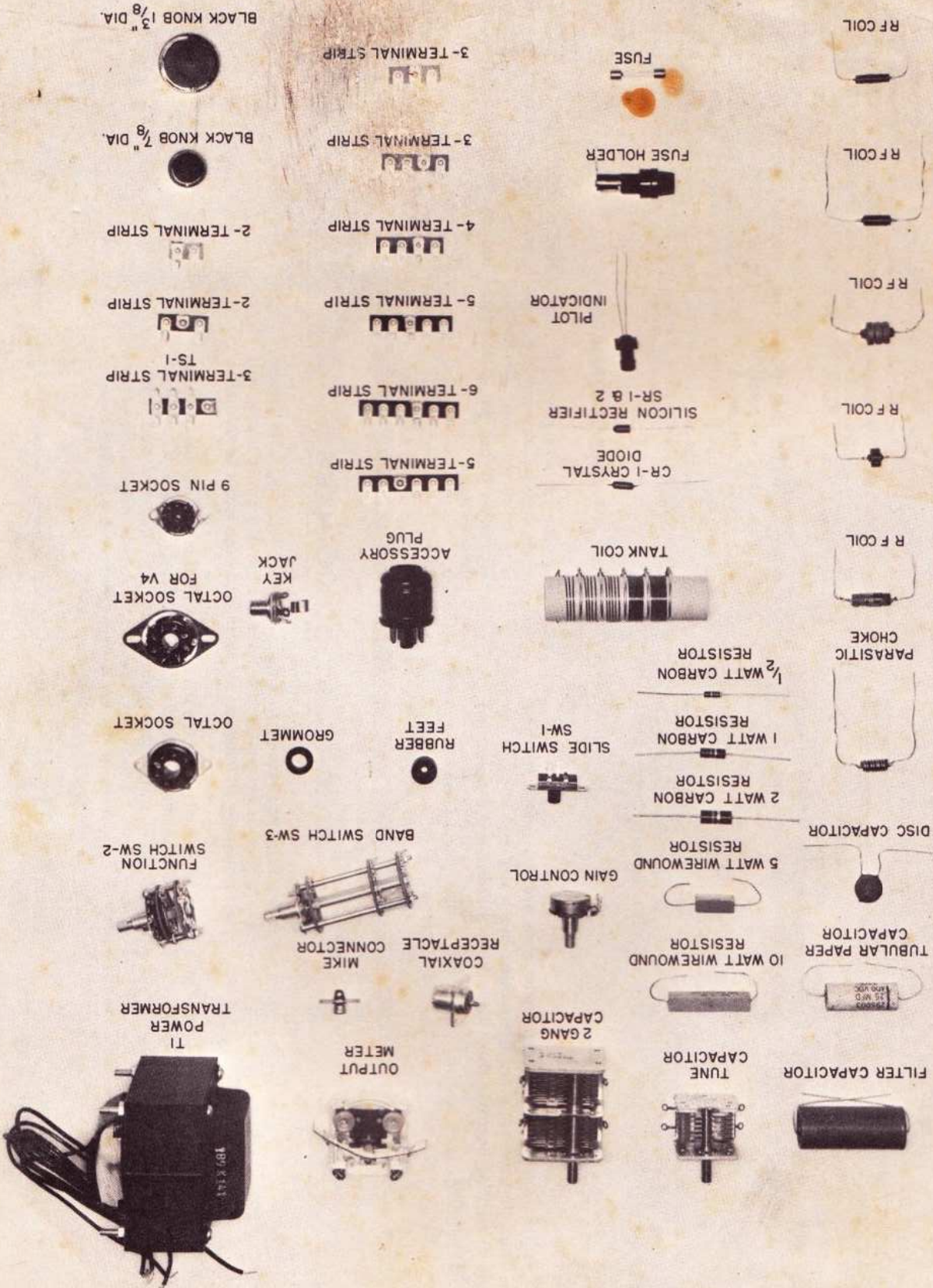



## ALLIED SERVICE FACILITIES

### FREE INFORMATION SERVICE

First, write a letter to us if your wired kit does not operate properly. Address KNIGHT-KIT Dept. at Allied Radio. Give the stock number of the kit, date of purchase and describe the problem. In a great many cases our technicians can determine corrective steps from the information in your letter. This free information service may save you the expense and inconvenience of returning the kit for repairs. Should it appear that work in our shop is necessary, we will send you a pre-addressed label and specific packing instructions for your kit.

### SPECIAL INSPECTION SERVICE

You may return this wired KNIGHT-KIT for inspection and repair within one year after purchase for a special service charge of \$7.50. Charges for kits returned after the one year period will be based on the length of time needed to repair the unit plus the cost of any parts required.

**PLEASE NOTE: Kits soldered with acid core solder, paste flux, or with irons cleaned on a sal ammoniac block are not eligible for repair or service because they have been permanently damaged by the acid flux.**

### PACKING INSTRUCTIONS

If you return this kit, pack it well. Do NOT use the original carton—it is too small for the assembled kit. To prevent damage in shipment, use a carton large enough so that cushioning material can be placed around the instrument. Cushion it well and tightly. Mark it: **FRAGILE—DELICATE ELECTRONIC EQUIPMENT.**

We recommend that this equipment be shipped **ONLY** by Railway Express, if at all possible, to forestall damage in shipment. Send the kit prepaid and insured. We will return the repaired kit to you C.O.D. as soon as repairs are completed. If you wish to save C.O.D. fees, your advance remittance may be enclosed for standard repair charges plus transportation costs. Any excess remittance will be refunded.

### IF YOUR KIT ARRIVED DAMAGED

If your kit was damaged in a parcel post shipment, please write us at once, describing the condition in which the shipment was received. If your kit was part of a Railway Express shipment that was damaged in transit, please notify the local Railway Express agent at once and then write us.

## KNIGHT-KIT GUARANTEE

Allied fully protects your Knight-Kit purchase with this exclusive money-back guarantee. Your Knight-Kit must meet with your complete satisfaction or your purchase price is refunded.

In addition, we guarantee that only premium-quality components are selected for use in Knight-Kits. Every Knight-Kit component is fully warranted against defects in material and workmanship for a period of one year from date of original purchase. Should replacement parts be required under this warranty, notify us promptly, including sufficient details to identify the required parts. Parts will be shipped without charge. We reserve the right to request the return of defective parts.



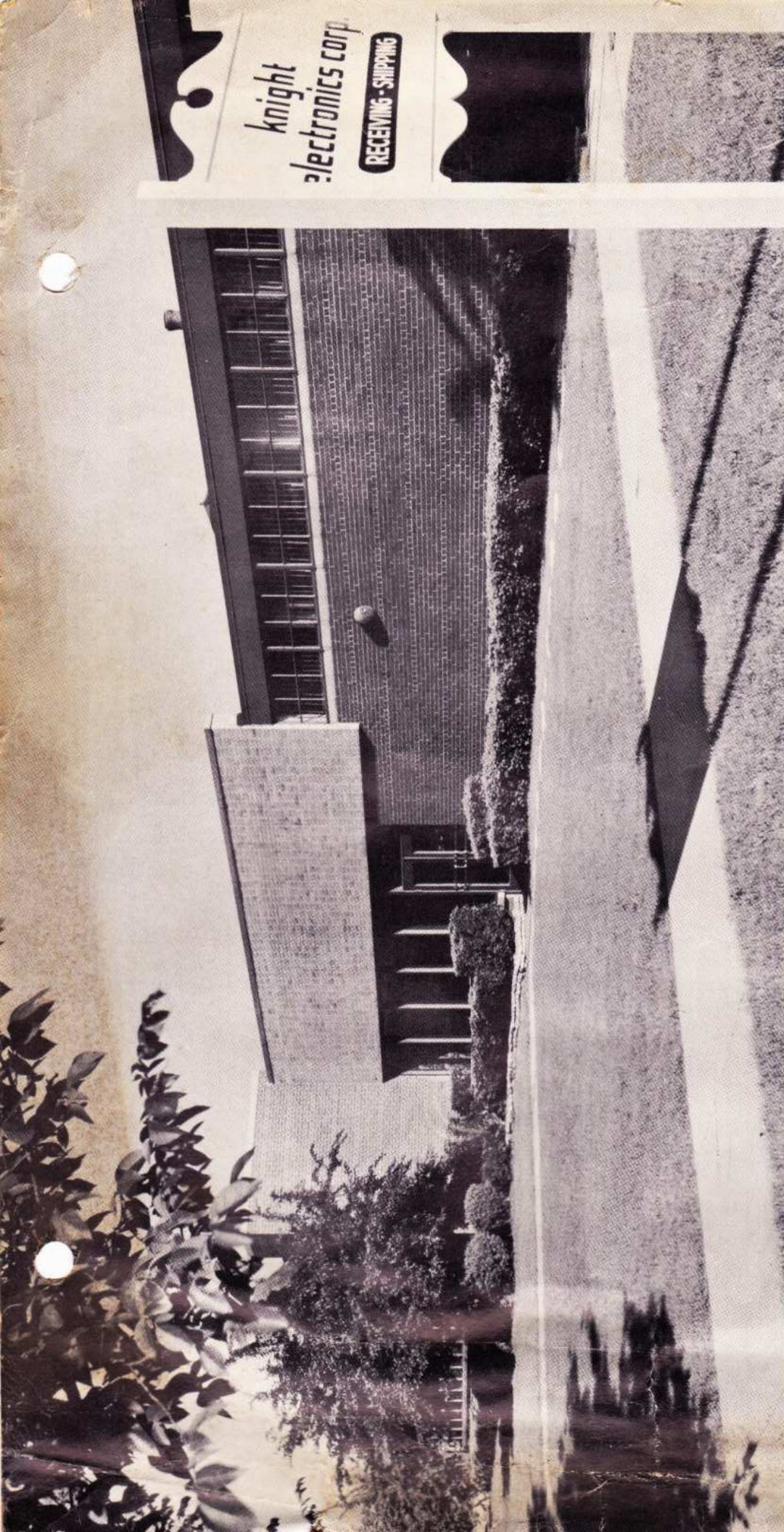

This is the new Knight Electronics Corporation Plant in Maywood, Illinois. A facility completely devoted to research, engineering, and manufacturing of electronic equipment in kit form. Here Knight pioneers in better electronic units at lower cost for electronic hobbyists, experimenters, laboratories, schools, and for industry.

***knight electronics corporation*** — A DIVISION OF ALLIED RADIO



**KNIGHT-KITS ARE YOUR BEST BUY.** THEY REPRESENT THE FINEST ELECTRONIC EQUIPMENT IN KIT FORM. TRULY CREATIVE ENGINEERING AND THE USE OF PREMIUM QUALITY PARTS ASSURE SUPERIOR PERFORMANCE.

**KNIGHT-KITS ARE "CONVENIENCE ENGINEERED".** EVERY DETAIL IS PLANNED FOR EASY CONSTRUCTION. RESISTORS ARE CARD-MOUNTED AND IDENTIFIED; WIRE IS PRECUT; SMALL PARTS ARE PACKAGED IN TRANSPARENT PLASTIC BAGS. SUPERB STEP-BY-STEP "SHOW HOW" MANUALS MAKE KNIGHT-KITS EASIEST TO BUILD.

**KNIGHT-KITS ARE THE FIRST CHOICE** OF EXACTING BUILDERS OF ELECTRONIC EQUIPMENT . . . THIS HAS BEEN TRUE SINCE THE EARLY 20'S. THERE IS AN OUTSTANDING KNIGHT-KIT FOR EVERY REQUIREMENT. EACH IS A REWARDING EXPERIENCE IN KIT CONSTRUCTION. YOU WILL BE PROUD TO BUILD AND OWN A KNIGHT-KIT.



*your*  
***knight-kit***<sup>®</sup>  
*guarantee*

***ALLIED*** fully protects your *Knight-Kit* purchase with this exclusive

## **MONEY-BACK GUARANTEE**

**Your Knight-Kit must meet with your complete satisfaction or your purchase price is refunded**